



CATALOGUE
2025

ASA Products Pty Ltd
23 Quinlan Road
Epping
VIC 3076



2015-2025

ASA Products are the Australian distributor of ASA Hydraulik. Based in Epping in Melbourne's North and owned by Chris Kennedy, we have been operating since 2015.

ASA Hydraulik are an Austrian manufacturer of high quality cooling technology, who have been manufacturing now for over 40 years.

ASA's standard oil/air cooler range is still setting the benchmark in the global market place. Our internal bypass options and pollution-resistant air fins are well known, working worldwide in all sorts of conditions.

Here in Melbourne we stock a full range of superior oil coolers, air coolers, plate coolers, air cooled heat exchangers, hydraulic couplings, butterfly valves, butterfly flanges, hydraulic oil coolers, air charged coolers, heat exchangers, sovatec fans and hydraulic accessories.

03 9397 6129

melbourne@asahydraulik.com

www.asahydraulics.com.au

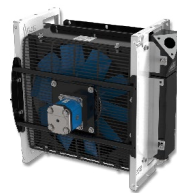

Low Line Series

TT Rail Series
DC / AC

TT Rail Series
Hydraulic Drive

ASA Series
DC / AC

ASA Series
Hydraulic Drive

Connector Kits

5

8

11

12

14

15



Rail Filter Series

Foot Mounting
Kits

Protection
Housings

Rubber Vibration
Absorbers

Temperature
Controllers

Temperature
Bypass Valves

16

16

17

17

18

19



Temperature
Sensors/Switches

ASA Fan Kits

H-Cube Series

Intergrated Oil/
Air Coolers

12 Series
Radiator Cores

Brazed Plate
Heat Exchangers

20

21

22

25

25

26

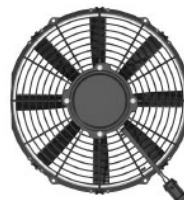

Offline Cooling
Systems

Gerotor
Pump Units

Butterfly Valves

Compensators

Sovatec MBD
12v Fans

Sovatec MBD
24v Fans

28

30













31

32

33

33



	Low Line Series				TT-Rail Series										ASA Series					
	LL 03	LL 06	LL 08	TT 07	TT 11	TT 13	TT 16	TT 20	TT 21	TT 25	TT 30	TT 36	TT 40	ASA 0177	ASA 0257	ASA 0367	ASA 0467	ASA 0567	ASA 0727	ASA 0927
DC 	●	●	●	●	●	●	●	●	●	●	●	●	●	●	●	●	-	-	-	-
DC Brushless 	-	○	○	○	○	○	○	○	○	○	○	○	○	○	○	○	-	-	-	-
AC 	●	●	●	●	●	●	-	●	●	-	●	-	●	●	●	●	●	●	●	
AC Compact 	●	●	●	●	●	●	-	-	-	-	-	-	-	-	-	-	-	-	-	
CC Offline 	-	-	-	●	●	-	●	-	-	●	-	●	-	●	●	●	●	-	-	
Hydraulic 	-	-	-	○	●	-	●	-	-	●	-	●	-	●	●	●	●	●	●	
Pressure Bypass 	○	○	○	○	○	○	○	○	○	○	○	○	○	○	○	○	○	○	○	
Thermo Bypass 	-	-	-	○	○	○	○	○	○	○	○	○	○	○	○	○	○	○	-	
DC Fan Speed Control 	●	●	●	●	●	●	●	●	●	●	●	●	●	●	●	-	-	-	-	
																				
	Low Line Series				TT-Rail Series										ASA Series					

- not available ● available as standard ○ on request (or standard with different part #)



ASA0013 Low Line Series

Part #	Voltage	Current	Ports	Max Pressure	Dimensions (mm)		
					H	W	D
ASA0013GD01	12v DC	0.30a	1/2" BSPP	26 Bar	119	120	92
ASA0013GD02	24v DC	0.15a	1/2" BSPP	26 Bar	119	120	92
ASA0013GE01	240v AC	0.12a	1/2" BSPP	26 Bar	119	120	92

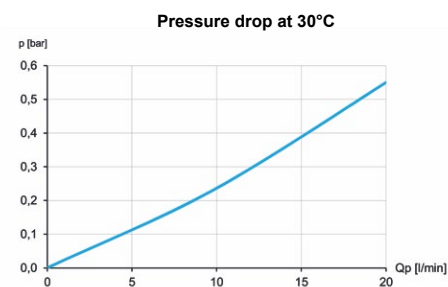
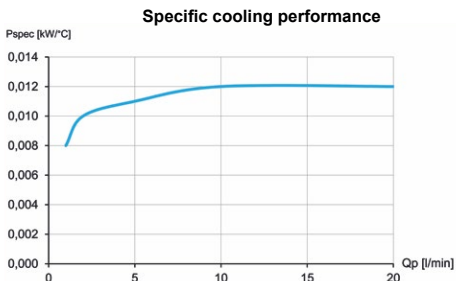

More options on page 18



ASA0023 Low Line Series

Part #	Voltage	Current	Ports	Max Pressure	Dimensions (mm)		
					H	W	D
ASA0023GD01	12v DC	5.4a	3/4" BSPP	26 Bar	180	229	98
ASA0023GD02	24v DC	2.7a	3/4" BSPP	26 Bar	180	229	98
ASA0023GE02	240v AC	0.25a	3/4" BSPP	26 Bar	180	229	98

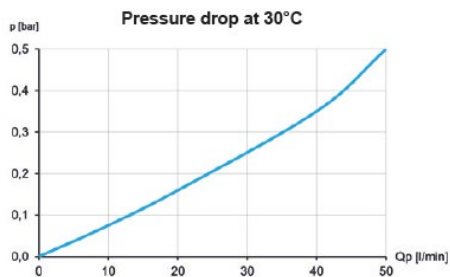
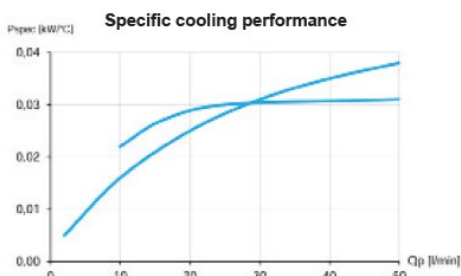

ASA0023GD



ASA0023GE



ASA0033 Low Line Series

Part #	Voltage	Current	Ports	Max Pressure	Dimensions (mm)		
					H	W	D
ASA0033GD01	12v DC	5.4a	3/4" BSPP	26 Bar	239	212	115
ASA0033GD02	24v DC	2.7a	3/4" BSPP	26 Bar	239	212	115
ASA0033GE02	240v AC	0.25a	3/4" BSPP	26 Bar	239	214	143



12v/24v DC

Specific cooling performance

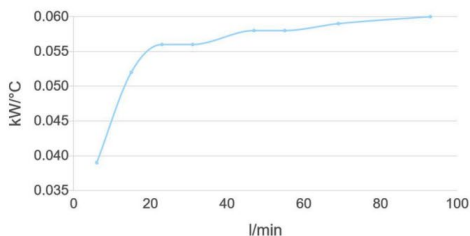

Pressure drop at 30°C

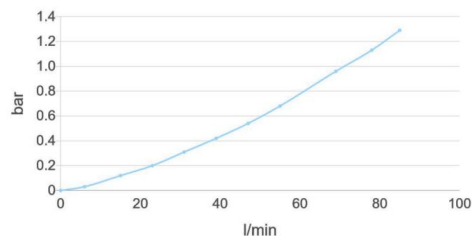

230v/400v AC

Specific cooling performance

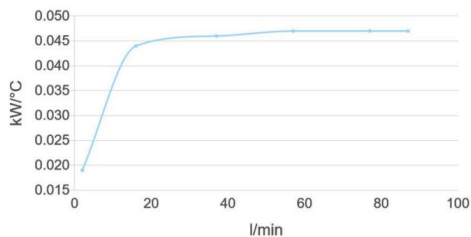

Pressure drop at 30°C

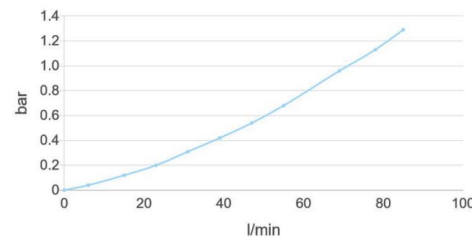

Low Line Series AC Compact

Part #	Voltage	Current	Bypass	Ports	Max Pressure	Dimensions (mm)		
						H	W	D
ASA0034GC2E	240v AC	0.25a	n/a	3/4" BSPP	26 Bar	255	250	246
ASA0034GC2EBP	240v AC	0.25a	Internal	3/4" BSPP	26 Bar	255	250	246
ASATT06GC2E	240v AC	0.45a	n/a	3/4" BSPP	26 Bar	290	323	226
ASATT06GC2EBP	240v AC	0.45a	Internal	3/4" BSPP	26 Bar	290	323	226
ASA0084GC2E	240v AC	0.55a	n/a	1" BSPP	26 Bar	380	386	226
ASA0084GC2EBP	240v AC	0.55a	Internal	1" BSPP	26 Bar	380	386	226



Specific cooling performance

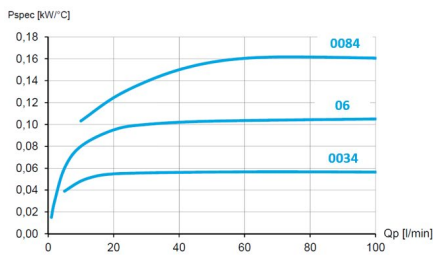

Pressure drop at 30°C

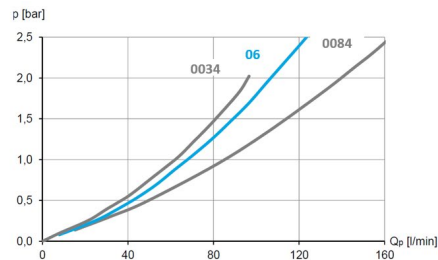

More options on page 18



Low Line Series DC

Part #	Voltage	Current	Bypass	Ports	Max Pressure	Dimensions (mm)		
						H	W	D
ASA0034GD01	12v DC	8.5a	n/a	3/4" BSPP	26 Bar	255	250	134
ASA0034GD01BP	12v DC	8.5a	Internal	3/4" BSPP	26 Bar	255	250	134
ASA0034GD02	24v DC	4.2a	n/a	3/4" BSPP	26 Bar	255	250	134
ASA0034GD02BP	24v DC	4.2a	Internal	3/4" BSPP	26 Bar	255	250	134
ASATT06GD03	12v DC	7.4a	n/a	3/4" BSPP	26 Bar	290	320	145
ASATT06GD03BP	12v DC	7.4a	Internal	3/4" BSPP	26 Bar	290	320	145
ASATT06GD04	24v DC	3.7a	n/a	3/4" BSPP	26 Bar	290	320	145
ASATT06GD04BP	24v DC	3.7a	Internal	3/4" BSPP	26 Bar	290	320	145
ASA0084GD01	12v DC	12.2a	n/a	1" BSPP	26 Bar	380	386	136
ASA0084GD01BP	12v DC	12.2a	Internal	1" BSPP	26 Bar	380	386	136
ASA0084GD02	24v DC	5.6a	n/a	1" BSPP	26 Bar	380	386	136
ASA0084GD02BP	24v DC	5.6a	Internal	1" BSPP	26 Bar	380	386	136
ASA0084GD03	12v DC	21.2a	n/a	1" BSPP	26 Bar	380	386	157
ASA0084GD03BP	12v DC	21.2a	Internal	1" BSPP	26 Bar	380	386	157
ASA0084GD04	24v DC	10.6a	n/a	1" BSPP	26 Bar	380	386	157
ASA0084GD04BP	24v DC	10.6a	Internal	1" BSPP	26 Bar	380	386	157
ASA0144GD01	12v DC	21.2a	n/a	1" BSPP	26 Bar	460	466	176
ASA0144GD01BP	12v DC	21.2a	Internal	1" BSPP	26 Bar	460	466	176
ASA0144GD02	24v DC	11.4a	n/a	1" BSPP	26 Bar	460	466	176
ASA0144GD02BP	24v DC	11.4a	Internal	1" BSPP	26 Bar	460	466	176



More options on page 18

0034/06/0084

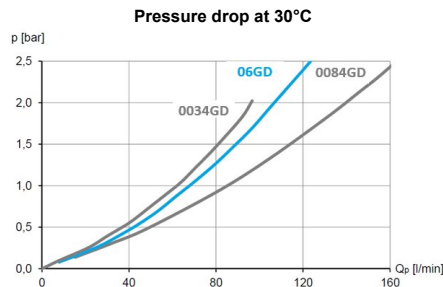
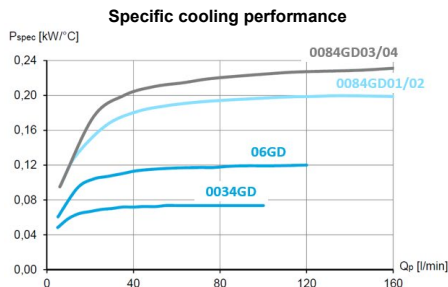

0144

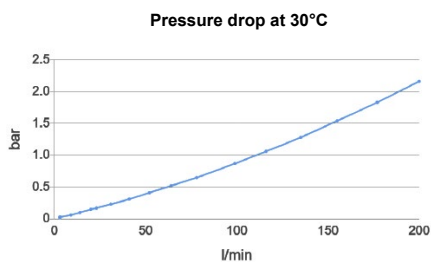
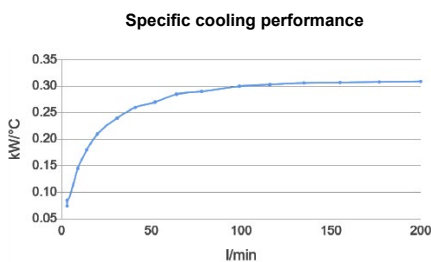



TT Rail Series - DC

Part #	Voltage	Current	Bypass	Max Pressure	Dimensions (mm)		
					H	W	D
ASATT07RD01	12v	10.4a	n/a	26 Bar	300	320	160
ASATT07RD02	24v	5.2a	n/a	26 Bar	300	320	160
ASATT07RD03	12v	16.2a	n/a	26 Bar	300	320	176
ASATT07RD04	24v	8.1a	n/a	26 Bar	300	320	176
ASATT11RD01	12v	20.8a	n/a	26 Bar	340	380	175
ASATT11RD02	24v	10.4a	n/a	26 Bar	340	380	175
ASATT13RD01	12v	20.8a	n/a	26 Bar	420	405	205
ASATT13RD02	24v	10.4a	n/a	26 Bar	420	405	205
ASATT16RD01	12v	18.6a	n/a	26 Bar	465	460	190
ASATT16RD02	24v	9.3a	n/a	26 Bar	465	460	190
ASATT21RD01	12v	18.6a	n/a	26 Bar	605	460	243
ASATT21RD02	24v	9.3a	n/a	26 Bar	605	460	243
ASATT25RD01	12v	18.6a	n/a	26 Bar	605	555	257
ASATT25RD02	24v	9.3a	n/a	26 Bar	605	555	257
ASATT36RD01	12v	2 x 22.6a	n/a	26 Bar	605	730	250
ASATT36RD02	24v	2 x 11.4a	n/a	26 Bar	605	730	250
ASATT07RD01BP	12v	10.4a	2 bar *	26 Bar	300	320	160
ASATT07RD02BP	24v	5.2a	2 bar *	26 Bar	300	320	160
ASATT07RD03BP	12v	16.2a	2 bar *	26 Bar	300	320	176
ASATT07RD04BP	24v	8.1a	2 bar *	26 Bar	300	320	176
ASATT11RD01BP	12v	20.8a	2 bar *	26 Bar	340	380	175
ASATT11RD02BP	24v	10.4a	2 bar *	26 Bar	340	380	175
ASATT13RD01BP	12v	20.8a	2 bar *	26 Bar	420	405	205
ASATT13RD02BP	24v	10.4a	2 bar *	26 Bar	420	405	205
ASATT16RD01BP	12v	18.6a	2 bar *	26 Bar	465	460	190
ASATT16RD02BP	24v	9.3a	2 bar *	26 Bar	465	460	190
ASATT21RD01BP	12v	18.6a	2 bar *	26 Bar	605	460	243
ASATT21RD02BP	24v	9.3a	2 bar *	26 Bar	605	460	243
ASATT25RD01BP	12v	18.6a	2 bar *	26 Bar	605	555	257
ASATT25RD02BP	24v	9.3a	2 bar *	26 Bar	605	555	257
ASATT36RD01BP	12v	2 x 22.6a	2 bar *	26 Bar	605	730	250
ASATT36RD02BP	24v	2 x 11.4a	2 bar *	26 Bar	605	730	250

* 1 or 5 bar bypass available on request



Must use with connector kits for ports - see page 15

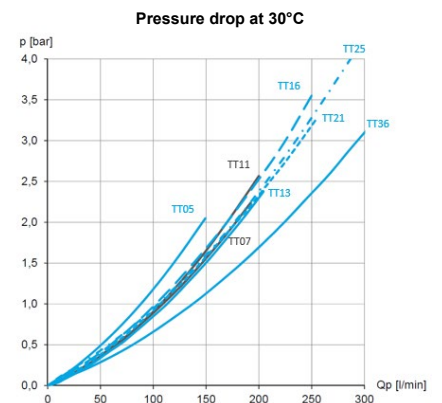
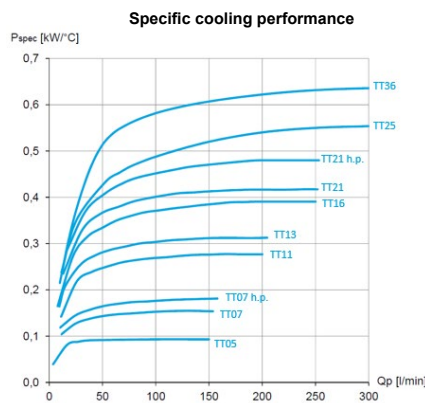



TT Rail Series Compact - 240v AC (Motor included)

Part #	Voltage	Current	Bypass	Max Pressure	Dimensions (mm)		
					A	B	L
ASATT07RC2E	240v	0.45a	n/a	26 Bar	300	325	260
ASATT11RC4E	240v	0.42a	n/a	26 Bar	340	385	260
ASATT11RC2E	240v	0.55a	n/a	26 Bar	340	385	260
ASATT13RC4E	240v	0.66a	n/a	26 Bar	420	410	260
ASATT16RC4E	240v	0.85a	n/a	26 Bar	465	465	285
ASATT07RC2EBP	240v	0.45a	2 bar*	26 Bar	300	325	260
ASATT11RC4EBP	240v	0.42a	2 bar*	26 Bar	340	385	260
ASATT11RC2EBP	240v	0.55a	2 bar*	26 Bar	340	385	260
ASATT13RC4EBP	240v	0.66a	2 bar*	26 Bar	420	410	260
ASATT16RC4EBP	240v	0.85a	2 bar*	26 Bar	465	465	285

* 1 or 5 bar bypass available on request



Must use with connector kits for ports - see page 15

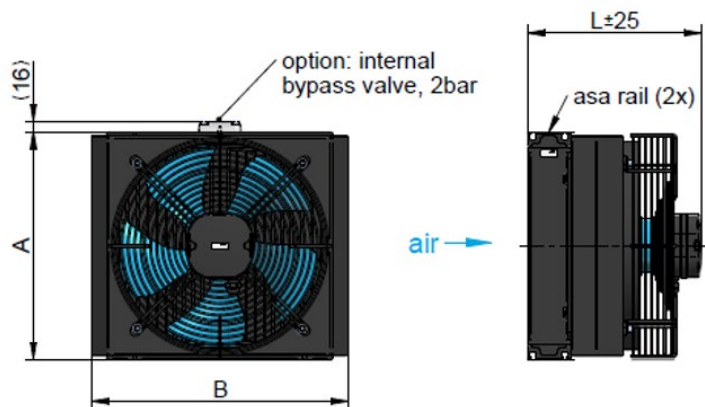

Specific cooling performance

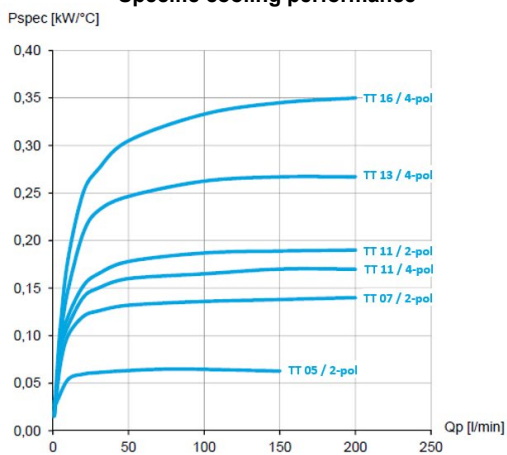

Pressure drop at 30°C

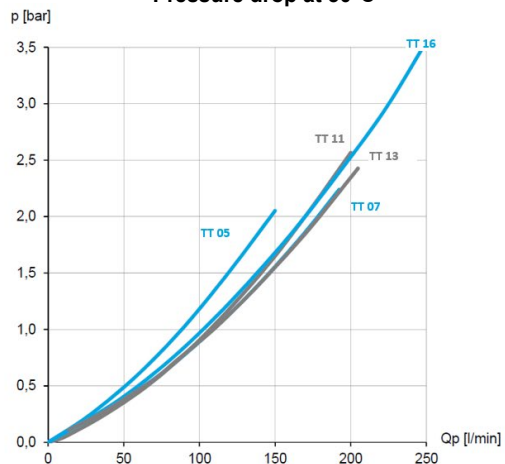

More options on page 18



TT Rail Series - 240v/415v AC (Motor not included)

Part #	Motor Size	Bypass	Max Pressure	Dimensions (mm)			
				A	B	C	L
ASATT07RA00NM	0.25kW 4P / 0.55kW 2P, D71 (B14)	n/a	26 Bar	300	320	193	396
ASATT11RA00NM	0.25kW 4P / 0.55kW 2P, D71 (B14)	n/a	26 Bar	340	380	193	398
ASATT16RA40NM	0.18kW 6P / 0.25kW 4P, D71 (B14)	n/a	26 Bar	465	462	219	414
ASATT16RA20NM	0.55kW 2P, D71 (B14)	n/a	26 Bar	465	462	219	414
ASATT21RA00NM	0.37kW 6P / 0.75kW 4P, D80 (B14)	n/a	26 Bar	605	558	222	444
ASATT25RA00NM	0.37kW 6P / 0.75kW 4P, D80 (B14)	n/a	26 Bar	605	558	219	440
ASATT07RA00BPNM	0.25kW 4P / 0.55kW 2P, D71 (B14)	2 bar*	26 Bar	300	320	193	396
ASATT11RA00BPNM	0.25kW 4P / 0.55kW 2P, D71 (B14)	2 bar*	26 Bar	340	380	193	398
ASATT16RA40BPNM	0.18kW 6P / 0.25kW 4P, D71 (B14)	2 bar*	26 Bar	465	462	219	414
ASATT16RA20BPNM	0.55kW 2P, D71 (B14)	2 bar*	26 Bar	465	462	219	414
ASATT21RA00BPNM	0.37kW 6P / 0.75kW 4P, D80 (B14)	2 bar*	26 Bar	605	558	222	444
ASATT25RA00BPNM	0.37kW 6P / 0.75kW 4P, D80 (B14)	2 bar*	26 Bar	605	558	219	440

* 1 or 5 bar bypass available on request



Must use with connector kits for ports - see page 15

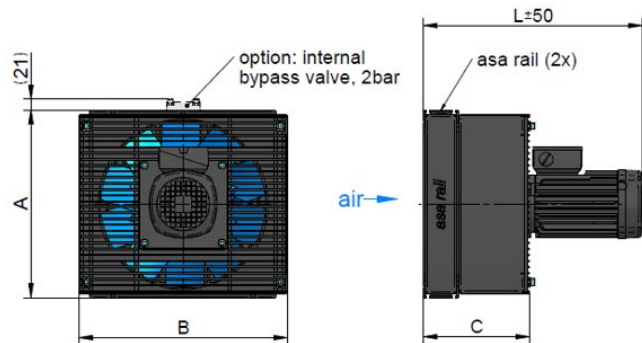

Specific cooling performance

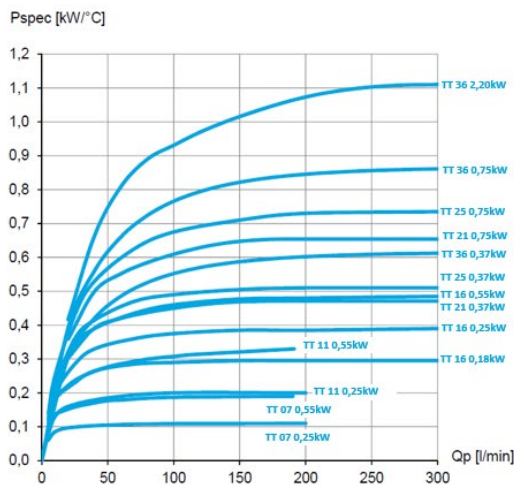

Pressure drop at 30°C

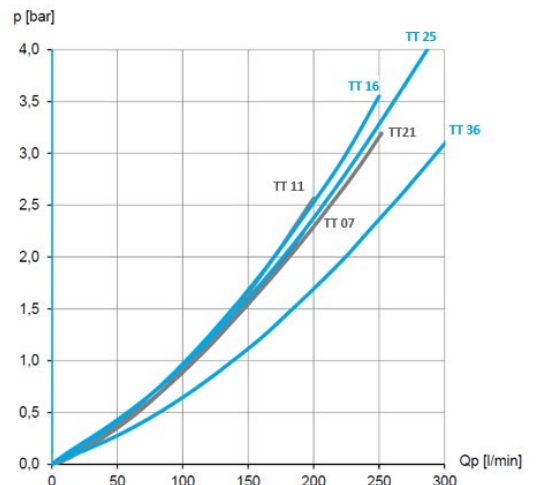

More options on page 18



TT Rail Series - Hydraulic Drive

Part #	Motor Size	Bypass	Max Pressure	Dimensions (mm)			
				A	B	C	L
ASATT11RH11	Group 2 DIN 11cc	n/a	26 bar	340	380	194	276
ASATT16RH11	Group 2 DIN 11cc	n/a	26 bar	465	462	219	292
ASATT25RH11	Group 2 DIN 11cc	n/a	26 bar	605	558	219	292
ASATT36RH11	Group 2 DIN 11cc	n/a	26 bar	605	736	239	367
ASATT11RH11BP	Group 2 DIN 11cc	2 bar*	26 bar	340	380	194	276
ASATT16RH11BP	Group 2 DIN 11cc	2 bar*	26 bar	465	462	219	292
ASATT25RH11BP	Group 2 DIN 11cc	2 bar*	26 bar	605	558	219	292
ASATT36RH11BP	Group 2 DIN 11cc	2 bar*	26 bar	605	736	239	367

* 1 or 5 bar bypass available on request



Must use with connector kits for ports - see page 15

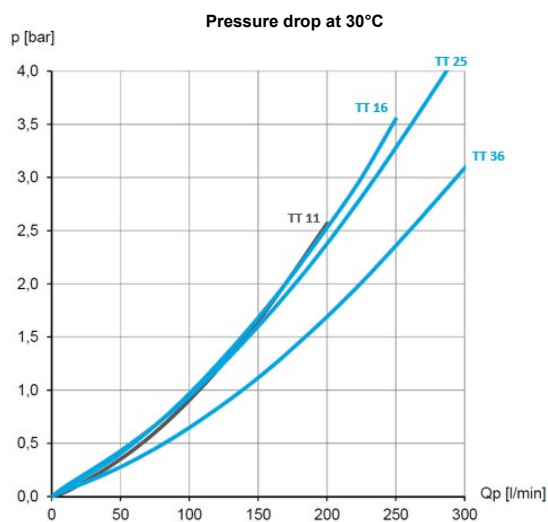
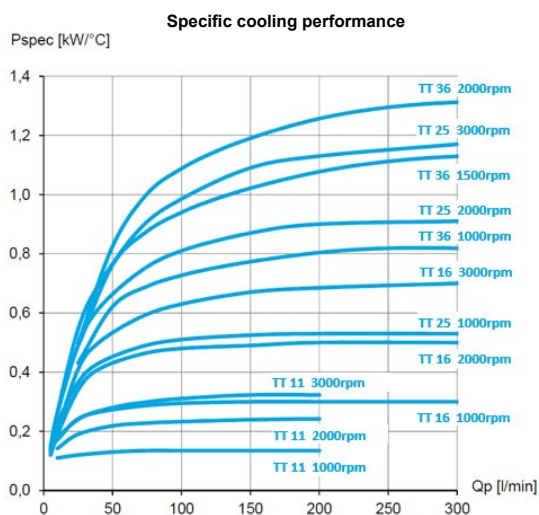
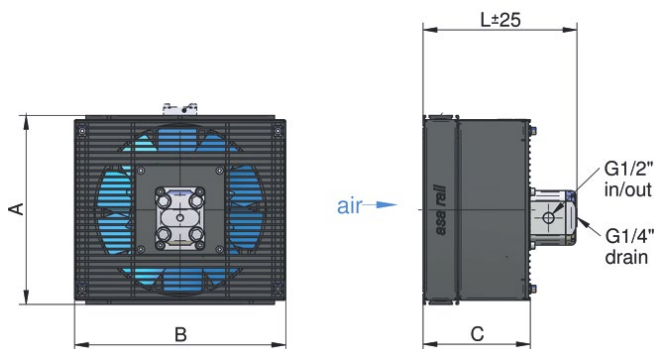

More options on page 18



ASA Series - DC

Part #	Voltage	Current	Bypass	Max Pressure	Dimensions (mm)		
					A	B	L
ASA0177AD01	12v	18.6a	n/a	26 Bar	470	590	228
ASA0177AD02	24v	9.3a	n/a	26 Bar	470	590	228
ASA0257AD01	12v	20.8a	n/a	26 Bar	555	690	259
ASA0257AD02	24v	10.4a	n/a	26 Bar	555	690	259
ASA0257AD03	12v	2 x 20.8a	n/a	26 Bar	555	690	259
ASA0257AD04	24v	2 x 10.4a	n/a	26 Bar	555	690	259
ASA0367AD01	12v	2 x 20.8a	n/a	26 Bar	650	770	271
ASA0367AD02	24v	2 x 10.4a	n/a	26 Bar	650	770	271
ASA0177AD01BP	12v	18.6a	2 bar	26 Bar	470	590	228
ASA0177AD02BP	24v	9.3a	2 bar	26 Bar	470	590	228
ASA0257AD03BP	12v	2 x 20.8a	2 bar	26 Bar	555	690	259
ASA0257AD04BP	24v	2 x 10.4a	2 bar	26 Bar	555	690	259
ASA0367AD01BP	12v	2 x 20.8a	2 bar	26 Bar	650	770	271
ASA0367AD02BP	24v	2 x 10.4a	2 bar	26 Bar	650	770	271

* 0.5 or 3.5 bar bypass available on request



Must use with connector kits for ports - see page 15

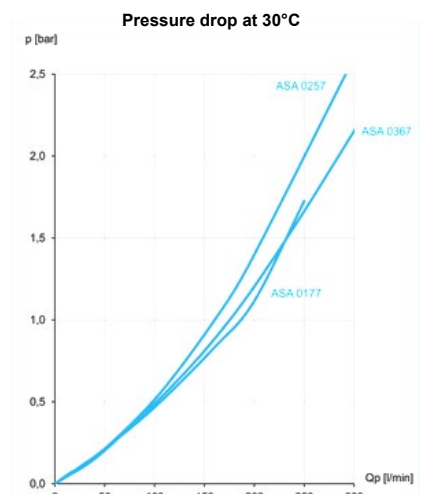
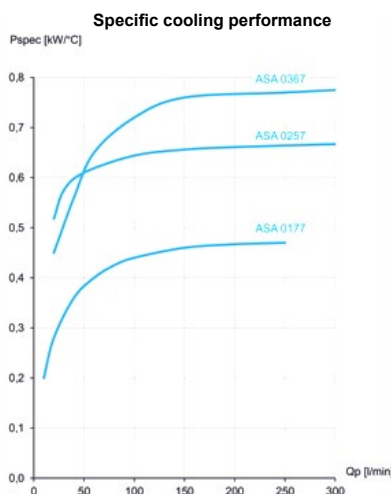
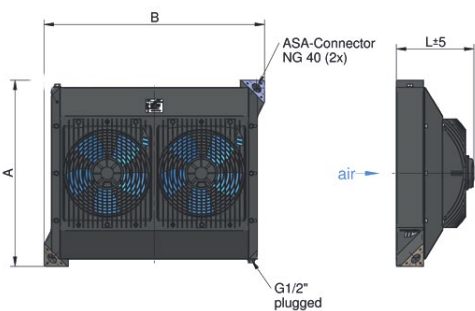
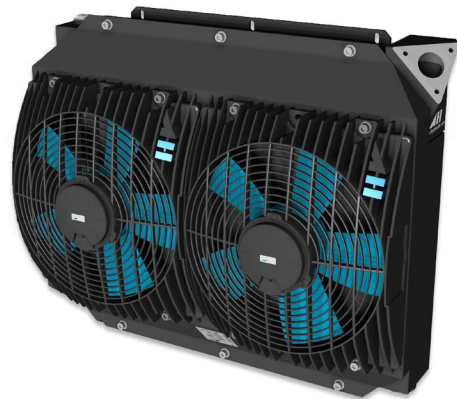

More options on page 18



ASA Series - 240/415v AC (Motor not included)

Part #	Motor Size	Bypass	Dimensions (mm)			
			A	B	C	L
ASA0177AA20NM	0.55kW 2P - D71(B14)	26 Bar	530	582	260	486
ASA0177AA40NM	0.25kW 4P 0.18kW 6P - D71(B14)	26 Bar	530	582	260	486
ASA0257AA47NM	0.75kW 4P - D80(B14)	26 Bar	635	682	270	520
ASA0257AA66NM	0.37kW 6P - D80(B14)	26 Bar	635	682	270	520
ASA0367AA46NM	0.75kW 4P - D80(B14)	26 Bar	720	762	280	533
ASA0367AA66NM	0.37kW 6P - D80(B14)	26 Bar	720	762	280	533
ASA0467AA47NM	0.75kW 4P - D80(B14)	26 Bar	785	837	290	550
ASA0467AA66NM	0.37kW 6P - D80(B14)	26 Bar	785	837	290	550
ASA0567AA47NM	0.75kW 4P - D80(B14)	26 Bar	860	920	290	543
ASA0567AA66NM	0.37kW 6P - D80(B14)	26 Bar	860	920	290	543
ASA0727AA4ANM	2.2kW 6P - D100(B14)	26 Bar	960	1012	360	640
ASA0727AA6ANM	1.5kW 6P - D100(B14)	26 Bar	960	1012	360	640
ASA0927AA6ANM	1.5kW 2P - D100(B14)	26 Bar	1100	1170	320	664



Must use with connector kits for ports - see page 15

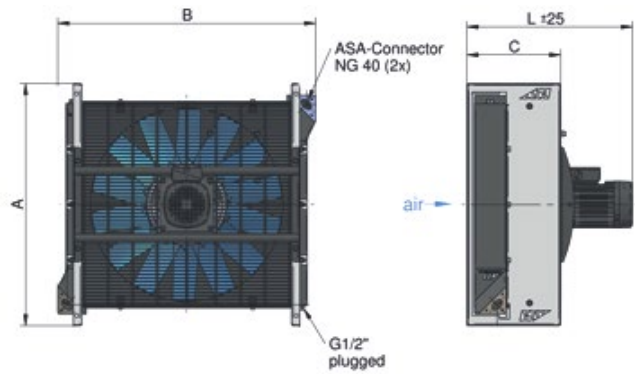

Specific cooling performance

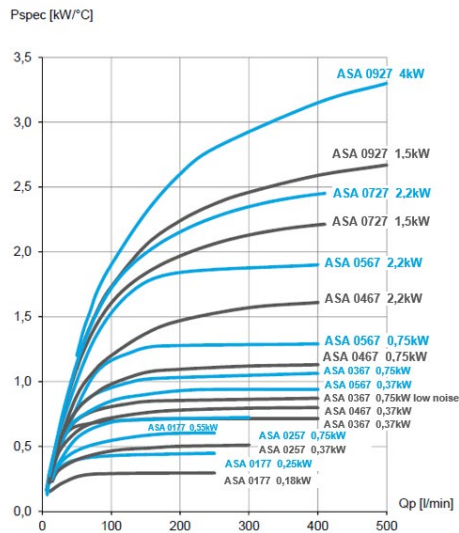

Pressure drop at 30°C

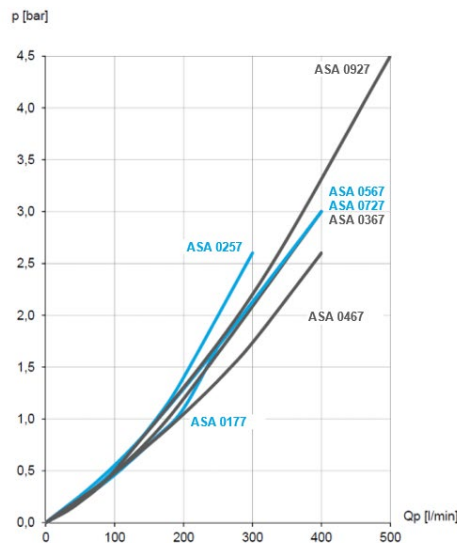

More options on page 18



ASA Series - Hydraulic Drive

Part #	Motor Size	Bypass	Dimensions (mm)		
			A	B	L
ASA0177AH11	Group 2 DIN 11cc	26 bar	530	582	364
ASA0257AH11	Group 2 DIN 11cc	26 bar	635	682	383
ASA0367AH11	Group 2 DIN 11cc	26 bar	720	762	430
ASA0467AH11	Group 2 DIN 11cc	26 bar	785	837	448
ASA0567AH11	Group 2 DIN 11cc	26 bar	860	920	448
ASA0727AH11	Group 2 DIN 11cc	26 bar	960	1012	521
ASA0927AH11	Group 2 DIN 11cc	26 bar	1100	1170	475



Must use with connector kits for ports - see page 15

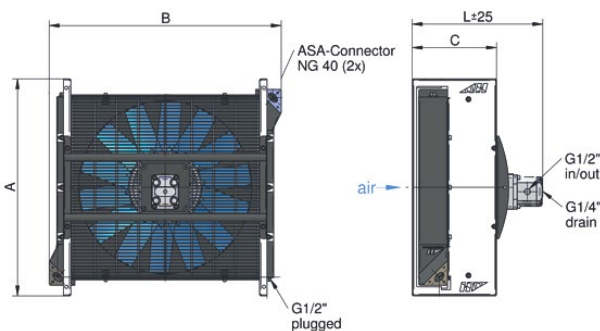
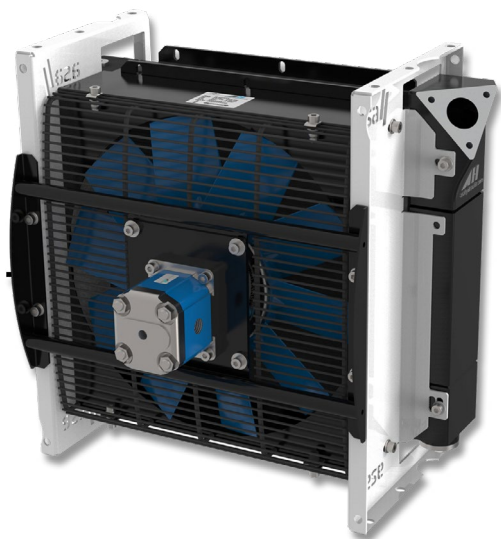

Specific cooling performance

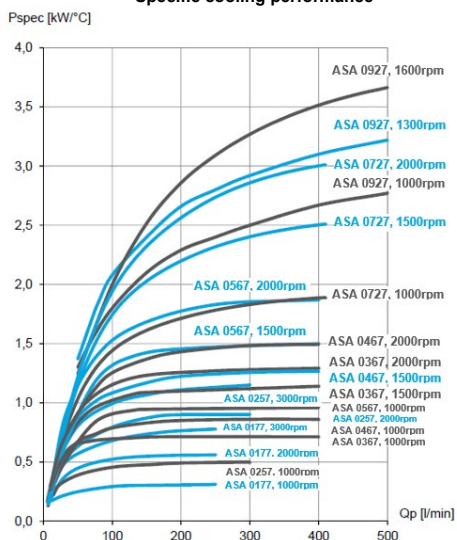

Pressure drop at 30°C

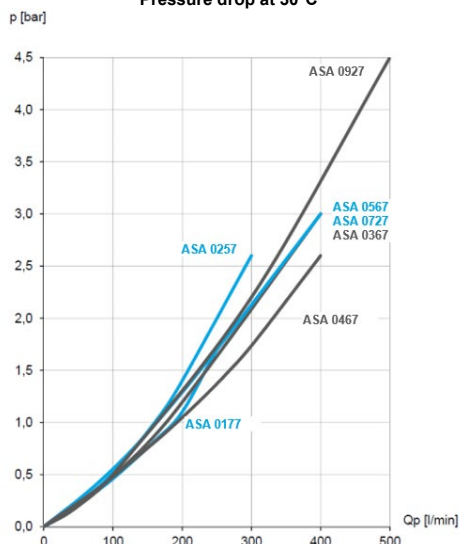

More options on page 18



TT Series Connector Kit

Part #	Port Size	Type
ILLZSET5G25	1" BSPP	2 x 90°
ILLZSET5G32	1.1/4" BSPP	2 x 90°
ILLZSET5G25A	1" BSPP	2 x Straight
ILLZSET5G25B	1" BSPP	1 x 90°, 1 x Straight

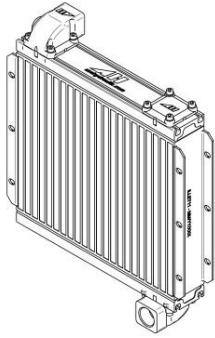

ILLZSET5G25A

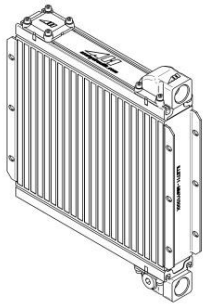

ILLZSET5G25B

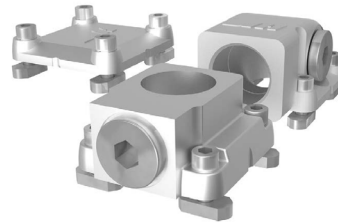

ASA Series Connectors

Part #	Port Size	Type
ILLZASA32G32	1.1/4" BSPP	2 connectors required per cooler
ILLZASA40G40	1.1/2" BSPP	2 connectors required per cooler
ILLZASA32U20	1.5/8" UNO	2 connectors required per cooler
ILLZASA40U24	1.7/8" UNO	2 connectors required per cooler
ILLZASA40-40G12	1/2" port sandwich plate	





Rail Filter Series

Part #	Spin-on Port Size	Max Flow	Micron	Bypass	Dimensions (mm)			
					A	B	C	D
ILLZRF11G2010	3/4" BSPP	60 lpm	10µm	2 bar	188	33	135	146
ILLZRF11G2025	3/4" BSPP	60 lpm	25µm	2 bar	188	33	135	146
ILLZRF12G2010	3/4" BSPP	100 lpm	10µm	2 bar	188	33	135	191
ILLZRF12G2025	3/4" BSPP	100 lpm	25µm	2 bar	188	33	135	191
ILLZRF21G3210	1.1/4" BSPP	180 lpm	10µm	2 bar	228	47	160	181
ILLZRF21G3225	1.1/4" BSPP	180 lpm	25µm	2 bar	228	47	160	181
ILLZRF22G3210	1.1/4" BSPP	220 lpm	10µm	2 bar	228	47	160	240
ILLZRF22G3225	1.1/4" BSPP	220 lpm	25µm	2 bar	228	47	160	240
HFZVEG15	Electrical clogging indicator G 1/2"							
HFZVOG15	Optical clogging indicator G 1/2"							

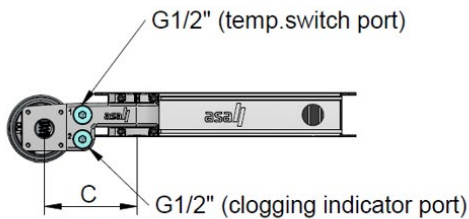
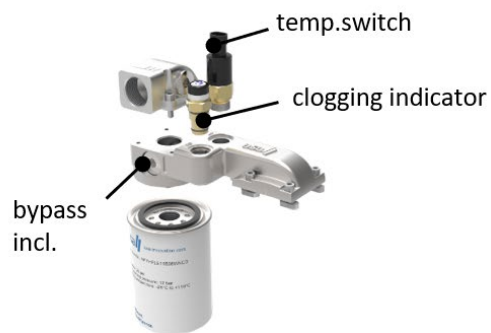
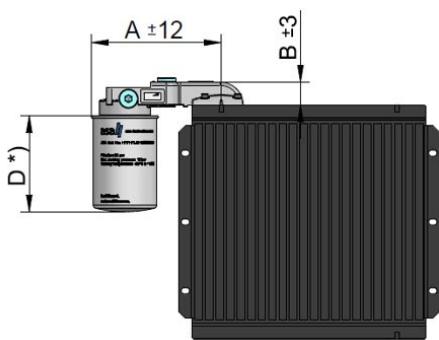

*) depending on the make of the filter element



Foot Mounting Kits

Part #	Description
ILLEFUSST06K	Mounting feet set (fits TT06)
ILLEFUSSTTK	Mounting feet set (fits TT07-TT36 Rail)
ILLEFUSSTHDK	Heavy duty mounting feet set (fits TT07-TT36 Rail)

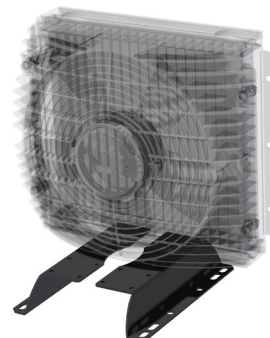
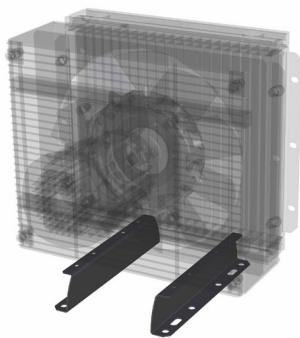



Protection Housings

Part #	Description
ILLEGAKTT07GT	Protection housing kit TT07 Rail
ILLEGAKTT11GT	Protection housing kit TT11 Rail
ILLEGAKTT16GT	Protection housing kit TT16 Rail

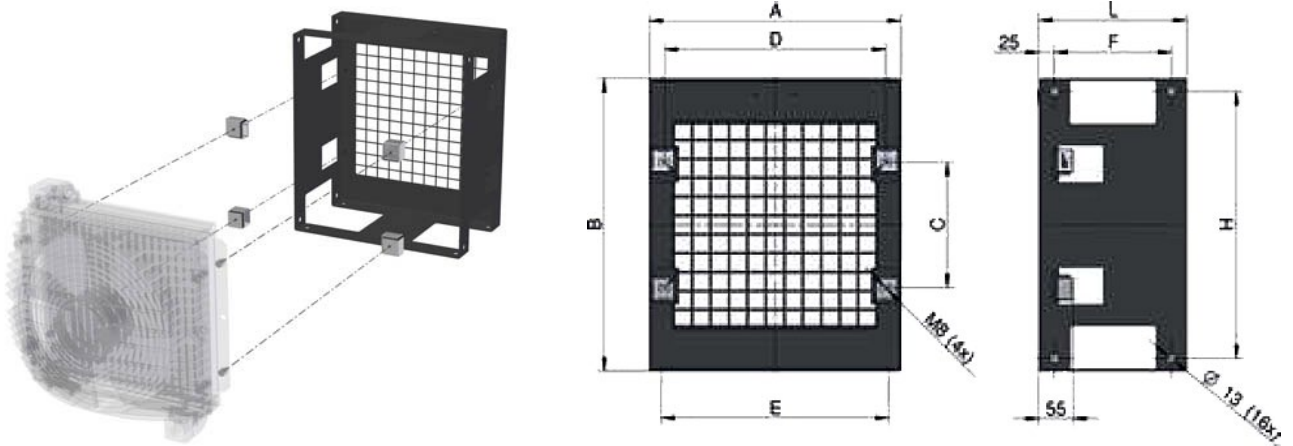

Rubber Vibration Absorbers

Part #	Material	Weight	M	Dimensions (mm)		
				A	B	C
MDGQ403008IIK	Zinc coated steel & natural rubber	0.13	M8 x 10	40	30	20
MDGQ504510IIK	Zinc coated steel & natural rubber	0.28	M10 x 12	50	45	25
MDGQ755512IIK	Zinc coated steel & natural rubber	0.659	M12 x 15	75	55	37.5
MDGQ1007516IIK	Zinc coated steel & natural rubber	1.92	M16 x 16.5	100	75	50

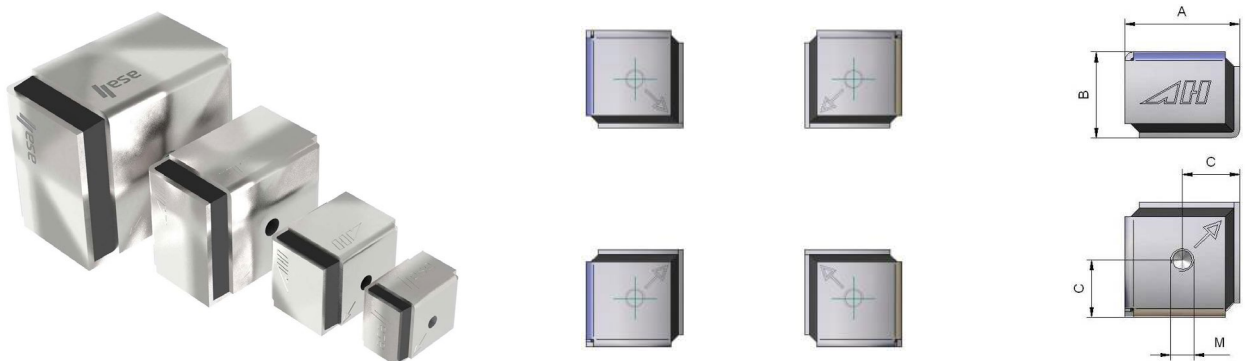

Assembly note: ensure all four arrows point to centre



Temperature Controller DC

Energy saving | Reduced noise level

Part #	Max Power Fan Motor	Max Current Fan	Protection	Weight	Supply
ILLZTC12-2K	310w	21a (14, 7v DC)	IP67	0.25kg	12v DC (9v-15v)
ILLZTC24-2K	340w	12a (24v DC)	IP67	0.25kg	24v DC (18v-32v)

Note: Two temperature controllers are required for coolers with twin fans



Technical Data	
Material	Polyamide
Mounting Instructions	Any mounting position
Temperature Sensor	ILLZTT5069K (control range 44-45 °C)
Temperature Switch	ILLZTH5069K (set point 50 °C, soft start)
Temperature Switch	ILLZTH6069K (set point 60 °C, soft start)
Temperature Switch	ILLZTH9069K (set point 90 °C, soft start)
Ambient Temperature Range	-20 °C to +85 °C
Storage Temperature Range	-60 °C to +110 °C
12v & 24v DC Coolers Combinations	LL04, LL06 / TT07-25 Rail / ASA0177 - 0367

When using with ILLZTT5069K sensor:

Fan rotation is controlled according to actual oil temperature from 45 °c to 55 °c (maximum fan speed reached).

When using with any IP69 type switch:

Only on/off function, with the advantage that start current is ramped up by controller, saving duration of the fan motor.



Temperature Controller DC - for reversable fan drive

Part #	Rated Power Supply	Max Operating Current	Protection	Weight	Supply
ILLZTCB00	7-40v	30 amp	IP67	0.29kg	12-24v DC

Note: Two temperature controllers are required for coolers with twin fans

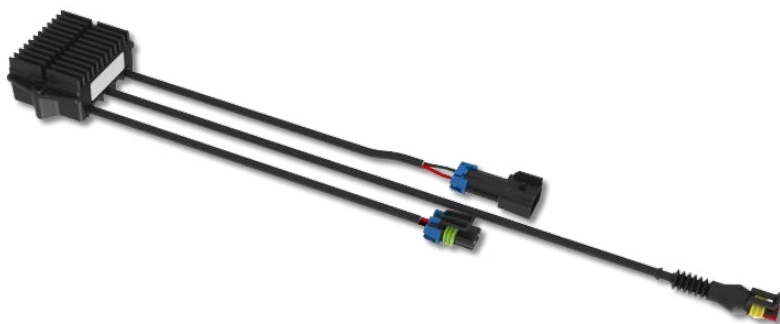

Operating fan cycle for reverse fan drive:

Temperature setup: fan starts at 40 °C, reached maximum speed at 60 °C.

- a) thermal switch = ON
- b) delay = 30 secs
- c) 20 secs for accelerations in reverse direction
- d) fan reversal = 30 secs (max speed)
- e) 20 secs for deceleration
- f) delay = 10 secs
- g) 20 secs for acceleration in normal direction
- h) fan (forward) = 45 mins (fan speed depends on oil temperature)
- i) 20 secs for deceleration
- j) delay = 15 secs
- k) repeat steps c-j

Technical Data	
Material	Polyamide
Mounting Instructions	Any mounting position
Temperature Sensor	Requires ILLZTT5069K temperature sensor
Oil Temperature Range	-20 °C to +85 °C
Ambient Temperature Range	-40 °C to +95 °C
Compatibility	All ASA DC fan units w/ Metri Pack 280 connection system



Temperature Controller AC

Part #	Voltage	Temperature Range	Protection	Weight
ILLZTCACK	115/230v AC	-30 °C to +120 °C	IP40	0.56kg

Technical Data

Material	Steel sheet metal, powder coated
Mounting Instructions	Any mounting position
Switch Control Range	-30 °C to +120 °C
Contacts Rating	C.1-10(2,5)a/250v
Contacts Rating	C.2-6(2,5)a/250v
Maximum Head Temperature	+85 °C
Maximum Bulb Temperature	+150 °C
Storage Temperature Range	-15 °C to +55 °C
Combinations	For use with TT07-TT36 Rail



Temperature Bypass Valve (TT Series only)

Part #	To suit	Max Working Temp.	Relief Temp.	Closing Temp.	Max Pressure
ILLZBPT5022K	TT Rail TT07-TT13	80 °C	< 58 °C	50-60 °C	26 bar
ILLZBPT5027K	TT Rail TT16-TT36	80 °C	< 58 °C	50-60 °C	26 bar

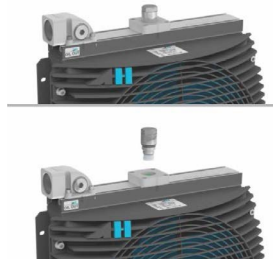
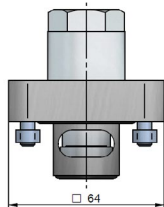
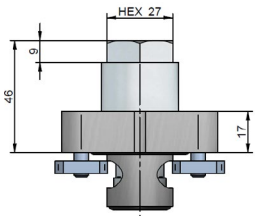



Temperature Sensors

Part #	Description	Connection	Protection	Weight
ILLZTT5069K	Temperature Sensor 1/2" BSP	AMP Superseal 1.5	IP69K	0.09kg
ILLZTT5067K	Temperature Sensor 1/2" BSP	Deutsch DT 06-2S	IP67K	0.13kg

Technical Data

Screw Part Material	Brass
Mounting Instructions	Any mounting position
Maximum Tightening Torque	50 Nm
Oil Temperature Range	-20 °C to +100 °C
Ambient Temperature Range	-20 °C to +85 °C
Storage Temperature Range	-60 °C to 110 °C
Temperature Control Unit 12v DC	ILLZTC12-2K
Temperature Control Unit 24v DC	ILLZTC24-2K
12v & 24v DC Coolers Combinations	LL04, LL06 / TT07-TT36 Rail / ASA0177-0367



ILLZTT5069K



ILLZTT5067K



ILLZTH4765K



ILLZTH5069K



Temperature Switches

Part #	Connection	Protection	Weight	Switch Temperature
ILLZTH5069K	AMP Superseal 1.5	IP 69K	0.10kg	50 °C +/-5
ILLZTH6069K	AMP Superseal 1.5	IP 69K	0.10kg	60 °C +/-5
ILLZTH9069K	AMP Superseal 1.5	IP 69K	0.10kg	90 °C +/-5
ILLZTH4765K	ISO 4400	IP 65	0.09kg	50 °C +/-5
ILLZTH6065K	ISO 4400	IP 65	0.09kg	60 °C +/-5
ILLZTH7067K	Deutsch DT 06-2S	IP 67	0.14kg	70 °C +/-5

Technical Data

Screw Part Material	Brass
Mounting Instructions	Any position
Maximum Tightening Torque	50 Nm
Number of Cycles	100,000
Counter Connector	Included
Contact	N.O. (Normal Open)
Minimum Current	200ma
Maximum Current	12v AC (10a), 24v AC (10a), 120v AC (15a), 230v AC (10a)
Oil Temperature Range	-20 °C to +100 °C
Ambient Temperature Range	-20 °C to +85 °C
Storage Temperature Range	-60 °C to 110 °C
Combinations	All 1/2" BSPP coolers & connectors



ASA Fan Kits

Part #	Voltage	Current	Airflow	Fits Cooler
ILLELE1434A1	12v DC	5.4a	Pull	Low Line 0043G, 0053G
ILLELE1434A2	24v DC	2.7a	Pull	Low Line 0043G, 0053G
ILLELE2250A1	12v DC	5.4a	Pull	Low Line 0023G
ILLELE2250A2	24v DC	2.7a	Pull	Low Line 0023G
ILLELE0240A1	12v DC	7.4a	Pull	Low Line 06G
ILLELE0240A2	24v DC	3.7a	Pull	Low Line 06G
ILLELE0240A3	12v DC	10.4a	Pull	TT Rail 07RD01
ILLELE0240A4	24v DC	5.2a	Pull	TT Rail 07RD02
ILLELE0240O5	12v DC	16.2a	Pull	TT Rail 07RD03
ILLELE0240O6	24v DC	8.1a	Pull	TT Rail 07RD04
ILLELE0295A1	12v DC	15.4a	Pull	Low Line 0084GD01
ILLELE0295A2	24v DC	7.7a	Pull	Low Line 0084GD02
ILLELE0295A5	12v DC	20.8a	Pull	ASA 0115, 257AD03 & 0367, TT Rail 11 & 13, Low Line 0084GD03
ILLELE0295A6	24v DC	10.4a	Pull	ASA 0115, 257AD04 & 0367, TT Rail 11 & 13, Low Line 0084GD04
ILLELE0295S5	12v DC	20.8a	Push	ASA 0115, 257AD03 & 0367, TT Rail 11 & 13, Low Line 0084GD03
ILLELE0295S6	24v DC	10.4a	Push	ASA 0115, 257AD04 & 0367, TT Rail 11 & 13, Low Line 0084GD04
ILLELE0385A1	12v DC	18.6a	Pull	ASA 0176 - 0257AD01, TT Rail 16 - 25
ILLELE0385A2	24v DC	9.3a	Pull	ASA 0176 - 0257AD02, TT Rail 16 - 25
ILLELE0385S1	12v DC	18.6a	Push	ASA 0176 - 0257AD01, TT Rail 16 - 25
ILLELE0385S2	24v DC	9.3a	Push	ASA 0176 - 0257AD02, TT Rail 16 - 25

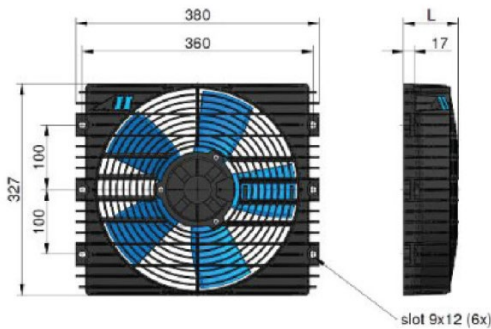

Fan kit 0240

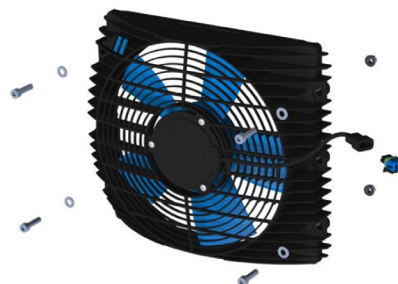
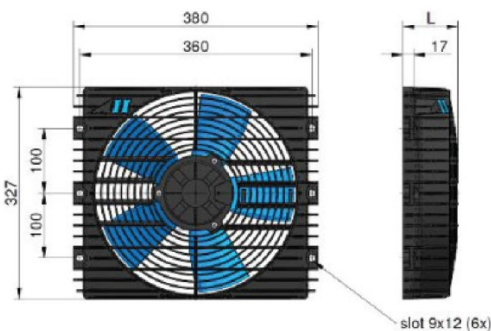

Fan kit 0295

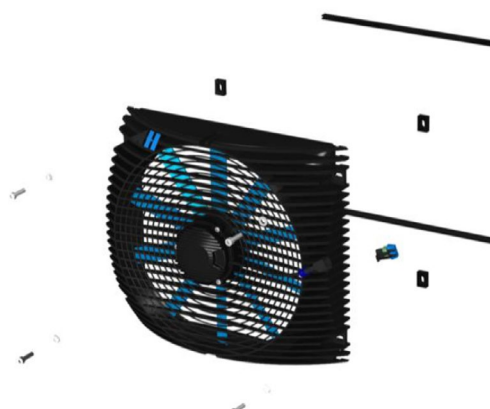
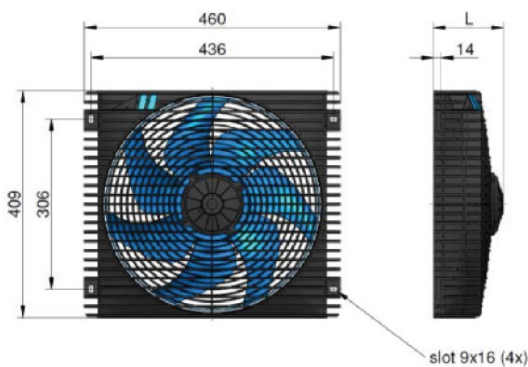

Fan kit 0385

Design your own H-cube!

- fan drive unit (a)
- cooler radiator (b)
- tank (c)
- side frames (d)
- electric clogging indicator(e)
- integration block (f)
- breather (g)
- filter (h)
- filter cap (i)
- optical clogging indicator (j)
- tank level gauge (k)
- connector with temperature switch port (l)

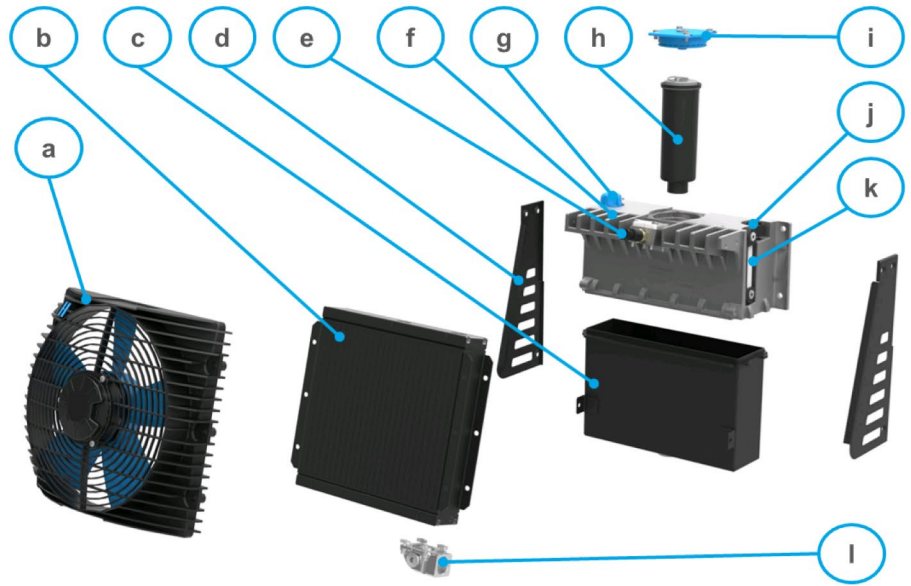

The integration block connects tank, filter and heat exchanger. These components can be, individually, varied in size and function. As a result of that, the system is able to customize to the application, while keeping a proven standard range product. Also integrated are tank level gauge, bypass valve, clogging indicator and temperature switch port. Due to this flexible system, all parts can be combined with the same control flange. The table below shows the possible options and its resulting code.

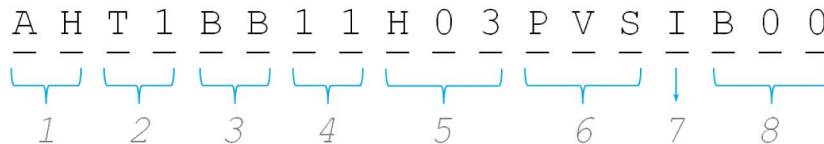

1 Product Series

AH	ASA H-Cube
----	------------

2 Tank Size*

T1	tank with 17l (EU**)
T2	tank with 23l (EU**)
T3	tank with 30l (EU**)
R5	tank with 4.5gal (US**)
R6	tank with 6.1gal (US**)
R8	tank with 7.9gal (US**)

3 Filter Combinations

	return filter	suction filter
00	none	none
B0	6µm (max.88lpm)	none
C0	10µm (max.180lpm)	none
D0	16µm (max.185lpm)	none
E0	25µm (max.195lpm)	none
0B	none	90µm
BB	6µm (max.88lpm)	90µm
CB	10µm (max.180lpm)	90µm
DB	16µm (max.185lpm)	90µm
EB	25µm (max.195lpm)	90µm

4 Cooler Size/Type

07	TT 07 rail, 2bar(30psi) bypass
11	TT 11 rail, 2bar(30psi) bypass
16	TT 16 rail, 2bar(30psi) bypass
25	TT 25 rail, 2bar(30psi) bypass

5 Fan Drive

D01	12V DC
D02	24V DC
H03	3cm³ hydraulic

6 Accessories & Options***

000	no options
00S	only stainless steel housing
KTO	temperature control DC
KTS	temp. control & stainless steel housing
PVS	tanker truck ¹⁾ block 210bar (3040 PSI) & stainless steel housing
PHS	tanker truck ¹⁾ block 350 bar (5070 PSI) & stainless steel housing

7 Clogging Indicator

0	no indicator
I	optical clogging indicator
E	electric clogging indicator
C	combined opt. & elect. indicator

8 Index / Customized

Bxx	special / customized specifications, to be advised e.g. position of connectors, special connectors, etc...
-----	--

* complete system content,

** EU version truck frame flange 150 x 450mm and BSP suction port
US version truck frame flange 5.5 x 17.5inch and NPT suction port

*** stainless steel and protection housing not in combination with cooler size TT 25!

¹⁾ Tanker Truck configuration includes the functions of a adjustable pressure relief valve for the whole hydraulic system, return line connection and hydraulic fan drive control -> see more information on the H-Cube data sheet, page 5 or contact us for further assistance.



H-Cube Series (US Version)

Part #	Tank Size	Fan Drive	Filter	Cooler Size	Options	Clogging Indicator
AH R5 D0 16 D02 KTO I	4.5 gallon	24v DC	16µm return filter*	TT16 Rail 2bar bypass	Temperature Control DC	Optical
AH R8 D0 16 D02 KTO I	7.9 gallon	24v DC	16µm return filter*	TT16 Rail 2bar bypass		Optical
AH R5 D0 16 H03 PVS 000 I	4.5 gallon	3cc Hydraulic	16µm return filter*	TT16 Rail 2bar bypass	Stainless Steel Housing**	Optical
AH R8 D0 16 H03 PVS 000 I	7.9 gallon	3cc Hydraulic	16µm return filter*	TT16 Rail 2bar bypass		Optical

* 1.75 bar bypass ** with adjustable inbuilt relief system 210 bar

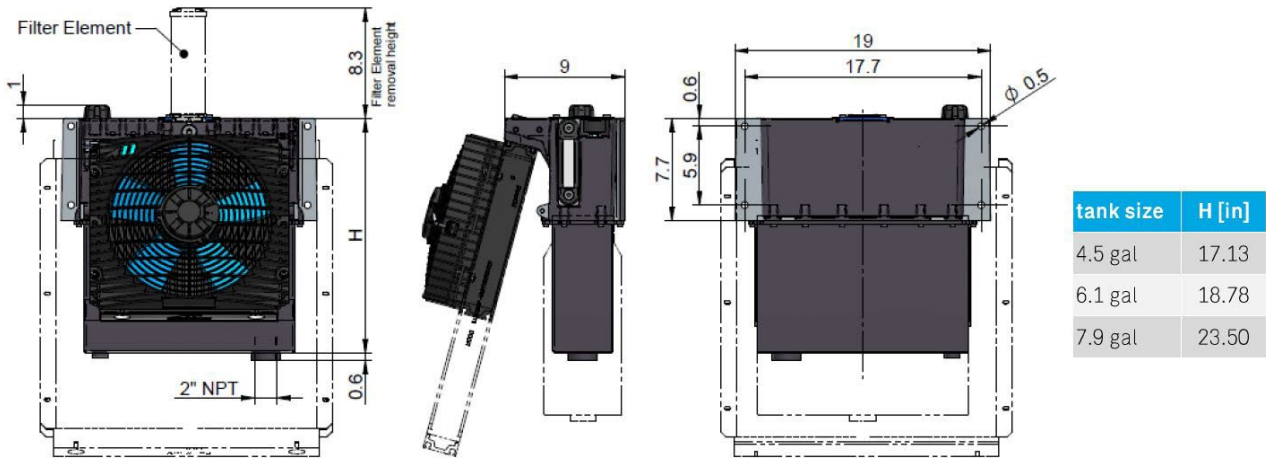

The actual performance output of the H-cube system is a combination of the cooler size (radiator core) and the type of fan drive. Choose the possible performances from the table below. The shown performance is the maximum possible specific cooling performance depending on the oil flow.

Heat dissipation in HP at 80°C temperature difference and 12V fan drive

cooler type	20 gpm	40 gpm	60 gpm
TT 07	16	16	
TT 11	26	28	29
TT 16	38	41	42
TT 25	67	71	73

Heat dissipation range (hydraulic drive) by pressure and oil flow

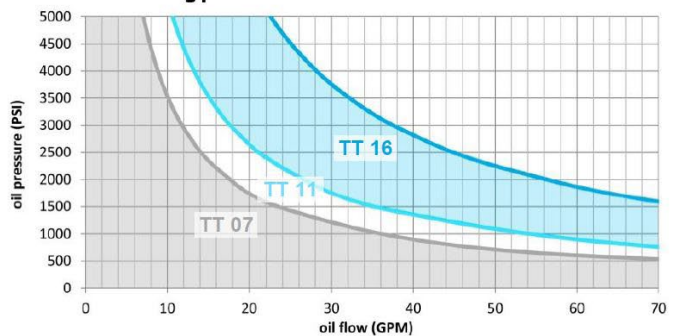

radiator material	brazed aluminium
radiator air fin	wavy
tank material	steel
integration block	anodized cast aluminium

return filter / suction filter	3 µ to 25 µ with 25 PSI or 44 PSI bypass
fan drive	12V or 24V DC
standard air flow direction	pulling
weight (dry)	55 lbs to max. 100 lbs



H-Cube Series (EU Version)

Part #	Tank Size	Fan Drive	Filter	Cooler Size	Options	Clogging Indicator
AH T3 D0 25 D02 KT0 E	30 Litre	24v DC	16µm return filter*	TT25 Rail 2bar bypass	Temperature Control DC	Electric

* 1.75 bar bypass

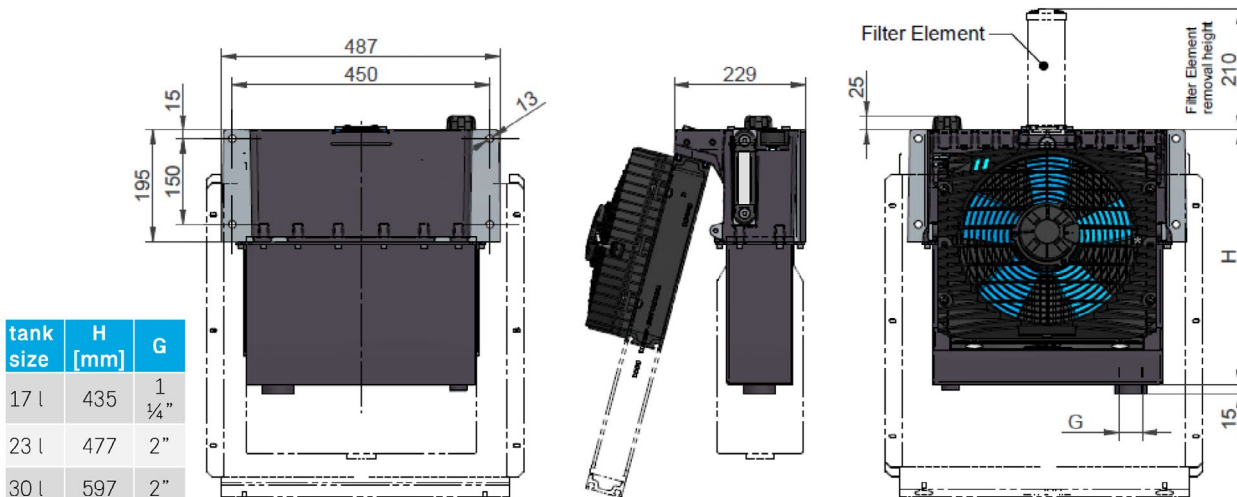

tank size	H [mm]	G
17 l	435	1 1/4"
23 l	477	2"
30 l	597	2"

specific cooling performance (with 12V or 24V DC fan drive)

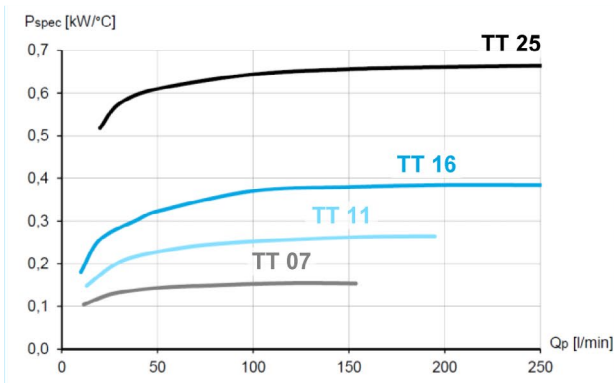

cooling performance range (tanker truck types), to select by pressure and oil flow

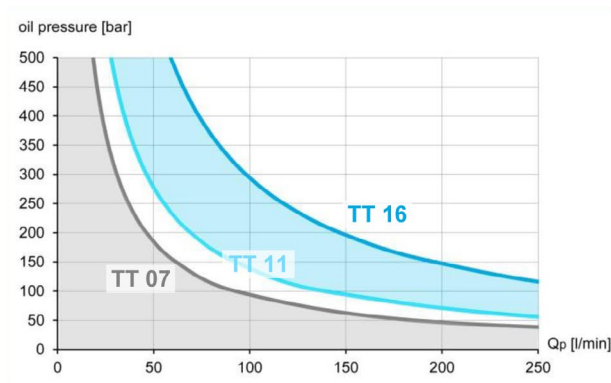

radiator material	brazed aluminium
radiator air fin	wavy
tank material	steel
integration block	cast aluminium

return filter rating	6 µ to 25 µ with 1,75 bar bypass
suction filter rating	90 µ (other micron on request)
fan drive	12V or 24V DC
weight (dry)	25 kg to max. 50 kg



Oil/Air Cooler with Integrated Suction Filter & Tanks

Part #	Motor	Current	Voltage	Max Pressure	Protection	Tank
ILLCO1101FTF	0.25 kW	15.0a	12v	1.2 bar	IP68	12 ltr
ILLCO1102FTF	0.25 kW	7.7a	24v	1.2 bar	IP68	12 ltr

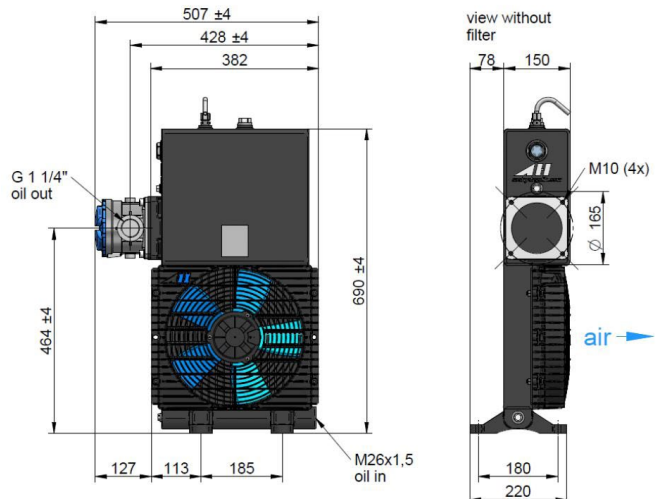
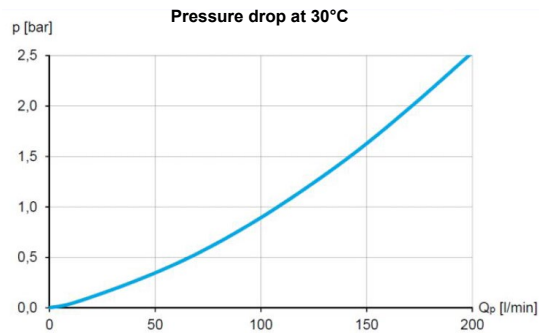
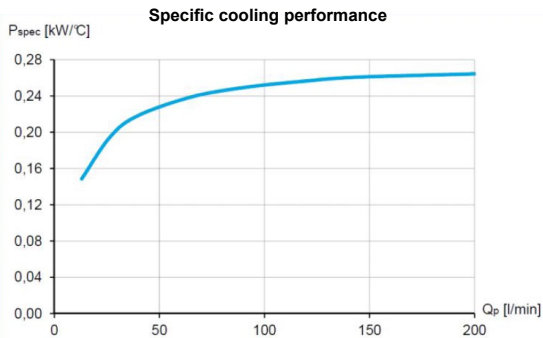

12 Series Radiator Cores

Part #	Material	Max Pressure	Ports	Size (mm)
ILLEC1242K	Aluminium	26 bar	SAE 16	330 x 220
ILLEC1260K	Aluminium	26 bar	SAE 16	540 x 220
ILLEC1290K	Aluminium	26 bar	SAE 16	540 x 320
ILLEC1292K	Aluminium	26 bar	SAE 16	540 x 420
ILLEC1296K	Aluminium	26 bar	SAE 20	540 x 630

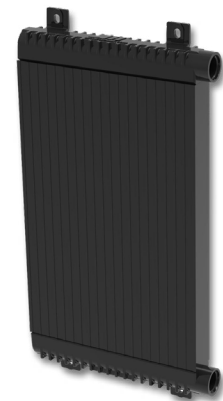
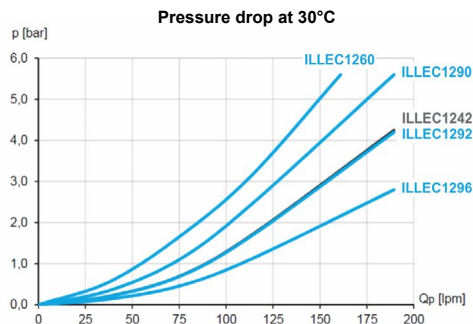
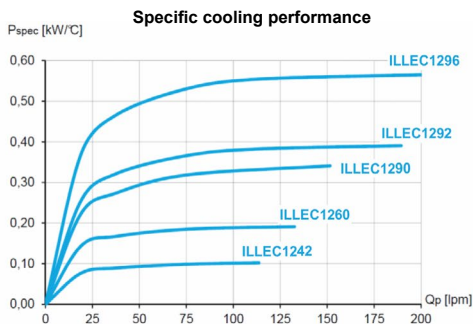



Brazed Plate Heat Exchangers

Part #	Max Pressure	Ports F/G	Dimensions (mm)						
			A	B	C	D	E	H	K
ILWPL10014EP	30 bar	1/2" BSPP	73	205	64.5	42	172	27	-
ILWPL20020EP	30 bar	3/4" BSPP	80	194	82	40	154	27	-
ILWPL22030EP	30 bar	1" & 3/4" BSPP	106	306	109	50	250	27	40
ILWPL22060EP	30 bar	1" & 3/4" BSPP	106	306	181	50	250	27	40
ILWPL40050EP	30 bar	1" BSPP	124	304	157	70	250	27	75
ILWPL53020EP	30 bar	1" BSPP	124	504	85	64	444	27	75
ILWPL53040EP	30 bar	1" BSPP	124	504	133	64	444	27	75
ILWPL53060EP	30 bar	1" BSPP	124	504	181	64	444	27	75
ILWPL70020EP	30 bar	1.1/2" BSPP	246	528	86.5	174	456	27	150
ILWPL70060EP	30 bar	1.1/2" BSPP	246	528	183	174	456	27	150
ILWPL70120EP	30 bar	1.1/2" BSPP	246	528	327	174	456	27	150
ILWPL70160EP	30 bar	1.1/2" BSPP	246	528	423	174	456	27	150

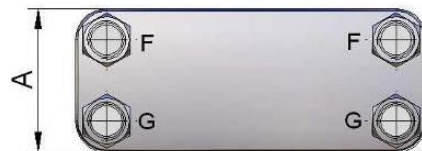
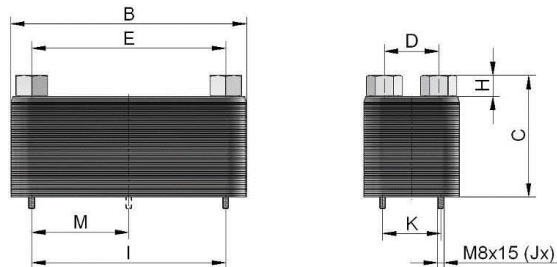

Specific cooling performance

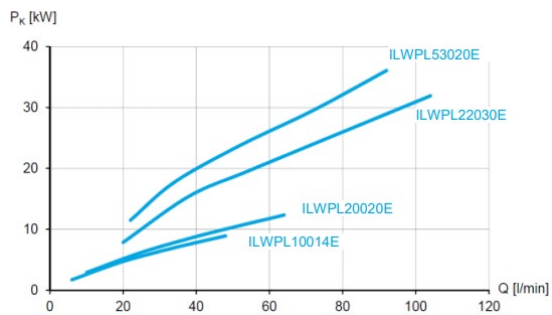

Pressure drop at 30°C

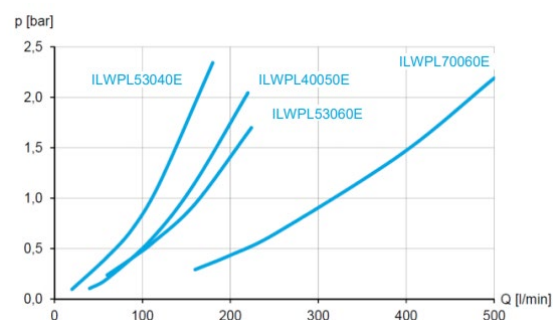
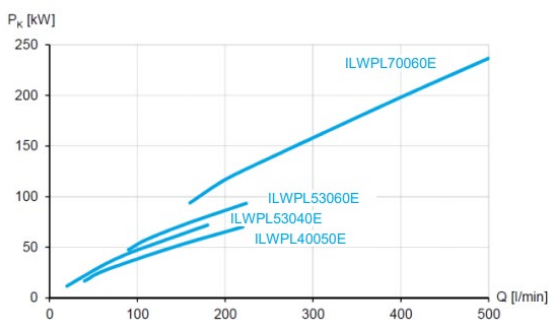
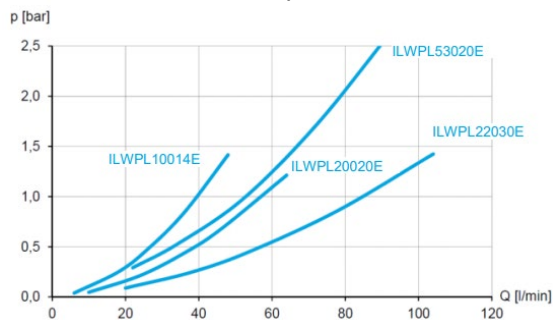



SPECIAL RANGE ST SERIES SHELL TUBE HEAT EXCHANGER



ASA Hydraulik's ST series is a modular range of shell and tube design heat exchangers. The main benefits of this design are the versatility of applications more independent of the used fluid quality and good maintenance ability compared to other heat exchanger types.

Our modular setup allows the best suitable connection and flow principle for lowest pressure drop at highest cooling performance.

We supply one, two or four pass configurations as well as different material combinations. For raising efficiency we offer all these configurations with hybrid finned tube technology.

**AVAILABLE ON REQUEST
CONTACT US FOR MORE DETAILS**

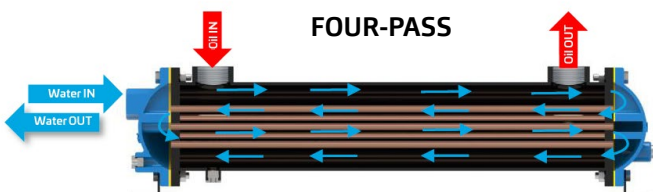
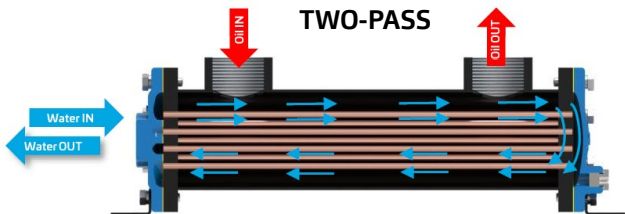
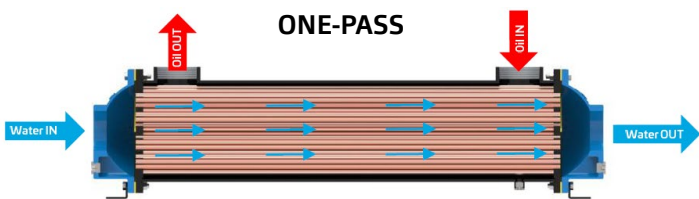



CC Series - TT Rail - AC (Gerotor Pump)

Larger sizes available on request

Part #	Motor Size	Max Pressure	Flow	Dimensions (mm)		
				A	N	L
ASATT07RA47CC	0.75kW 4P 415v	10 bar	30 lpm	355	320	493
ASATT11RA47CC	0.75kW 4P 415v	10 bar	30 lpm	395	380	495
ASATT16RA47CC	0.75kW 4P 415v	10 bar	30 lpm	520	460	511
ASATT25RA47CC	0.75kW 4P 415v	7 bar	30 lpm	660	558	511

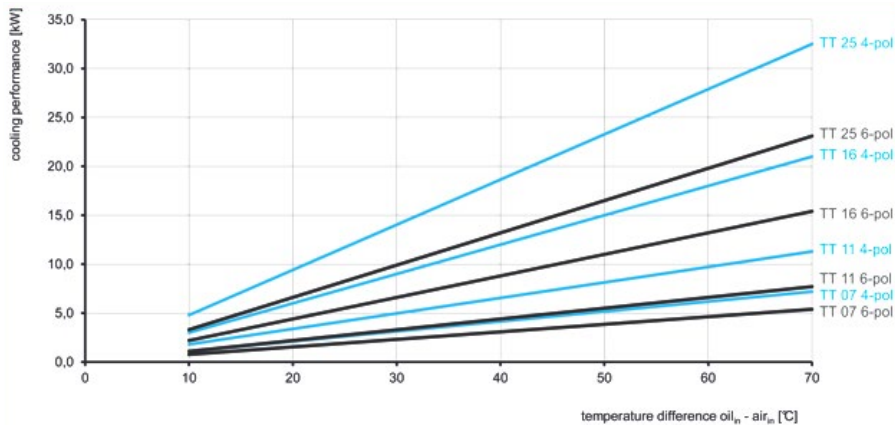
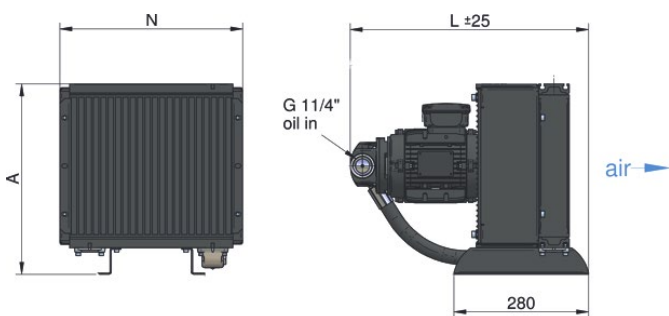

More options on page 18

Connector Kits

Part #	Port Size	Type
ILLZATT53G25K	1" BSPP	Rail connector



CC Series - Offline - AC (Screw Pump)

Part #	Motor Power	Motor Current	Oil Flow	Max Pressure	Weight	Dimensions (mm)			
						A	B	L	N
ASA0177AA49CC	1.5 kW 4P	3.35a	60 lpm	10 bar	70.7	530	400	807	601
ASA0257AA49CC	1.5 kW 4P	3.35a	60 lpm	10 bar	80	635	410	817	701
ASA0367AA49CC	1.5 kW 4P	3.35a	60 lpm	8 bar	90.4	720	420	827	781
ASA0467AA49CC	1.5 kW 4P	3.35a	60 lpm	8 bar	107.7	785	420	837	856
ASA0567AA49CC	1.5 kW 4P	3.35a	60 lpm	8 bar	108.1	860	410	837	931
ASA0177AA68CC	0.75 kW 6P	1.95a	40 lpm	9 bar	66.7	530	400	807	601
ASA0257AA68CC	0.75 kW 6P	1.95a	40 lpm	9 bar	76	635	410	817	701
ASA0367AA68CC	0.75 kW 6P	1.95a	40 lpm	8 bar	86.4	720	420	827	781
ASA0467AA68CC	0.75 kW 6P	1.95a	40 lpm	8 bar	103.7	785	420	837	856
ASA0567AA68CC	0.75 kW 6P	1.95a	40 lpm	8 bar	104.1	860	410	837	931



Must use with connector kits for ports - see page 15

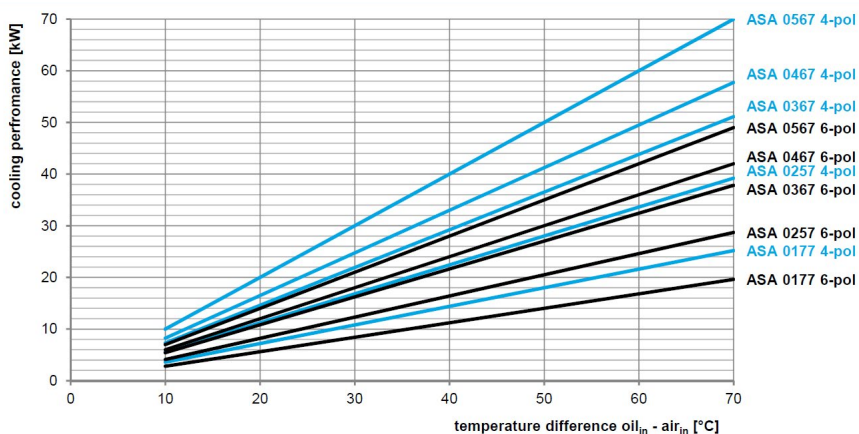
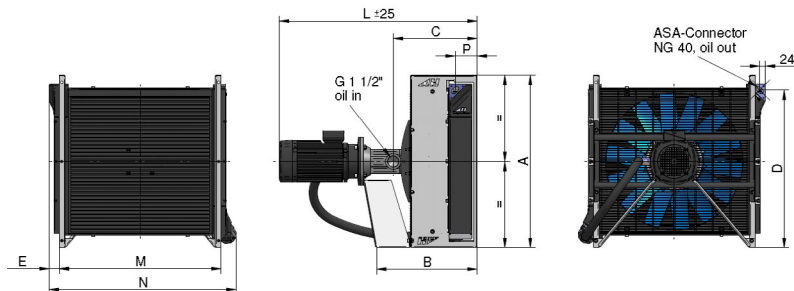
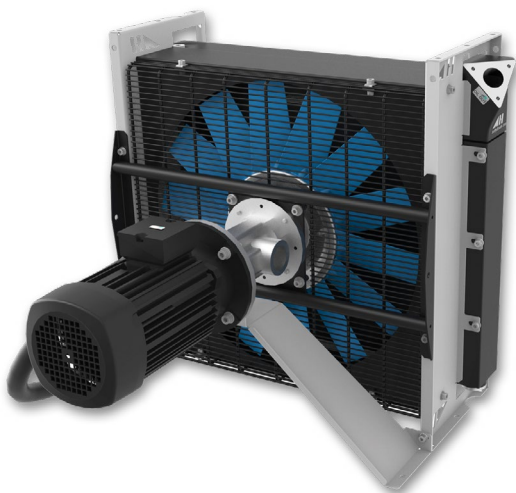



Gerotor Pump Unit - 415v

Part #	HY0200758G	HY0201108G
List Price \$	2469.00	3589.00
Motor Power	0.75 kW	1.10 kW
Maximum Oil Viscosity	100 cSt	250 cSt
Maximum Current	2.1a	2.6a
60 Hz	Possible, 276/480v	On request
Weight	13.8kg	16.6kg
Oil Flow	30 lpm	
Negative Pressure	-0.4 bar	
Poles	4 pole	
Ambient Temperature	-20 °C to +40 °C	
Maximum Working Pressure	10 bar	
Maximum Oil Temperature	80 °C (100 °C on request)	
Fluids	Mineral oils	
Pump Housing	Aluminium	
Gerotor	Sintered Steel	

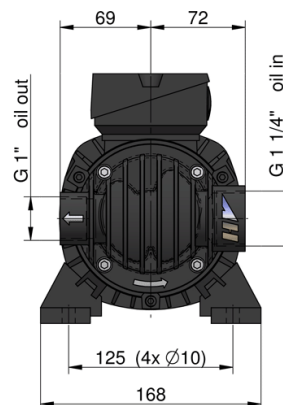
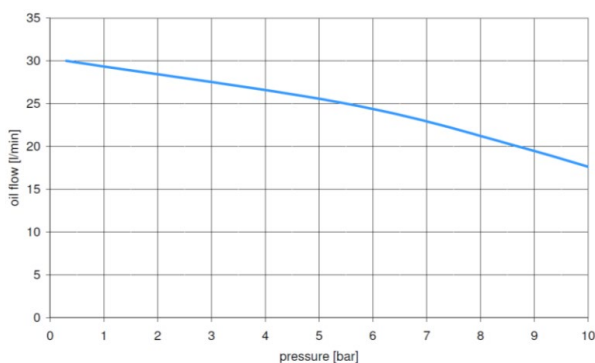
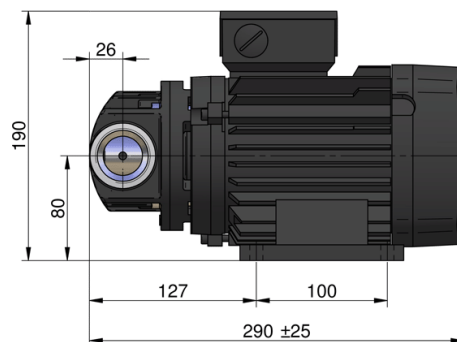

GEROTOR PUMP GENERATION 2

The GERO generation 2 gerotor pumps are constant displacement pumps with compact measurements, high cleanliness and a robust attribute. This is a completely new design with trend-setting modules to serve for highest flexibility to the actual application.

The aluminium body of the housing, the steel shaft and the standard NBR sealings are the perfect match for any mineral oil application. The pump is recommended for lubrication circuits as well as for oil supply, cooling and filtration systems.

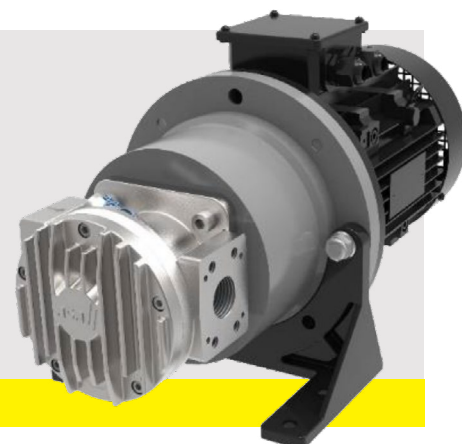

AVAILABLE ON REQUEST - CONTACT US FOR MORE DETAILS



Suction Butterfly Valves

Part #	Size	Max Working Pressure	Differential Pressure
SDA0040	DIN40 SAE 1.1/2"	7 bar	6 bar
SDA0050	DIN50 SAE 2"	7 bar	6 bar
SDA0063	DIN65 SAE 2.1/2"	7 bar	6 bar
SDA0080	DIN80 SAE 3"	7 bar	6 bar
SDA0100	DIN100 SAE 4"	7 bar	6 bar
SDA0125	DIN125 SAE 5"	7 bar	6 bar

SDA Series (front)

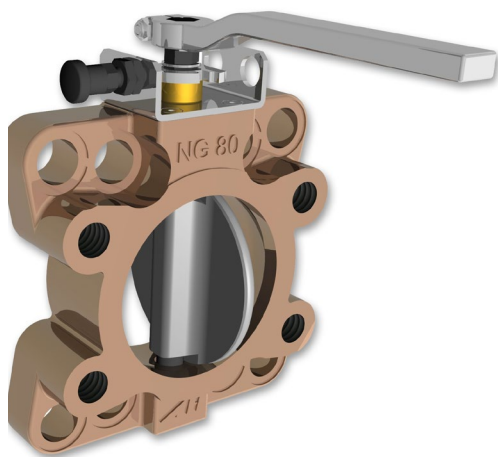

SDA Series (back)

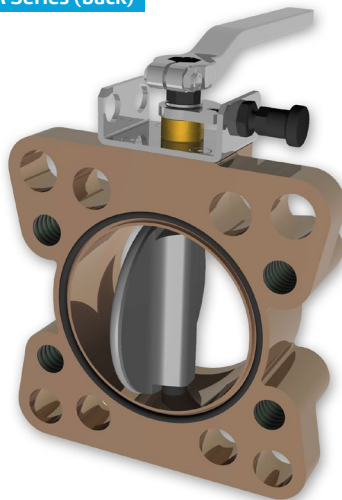

SDAET Series

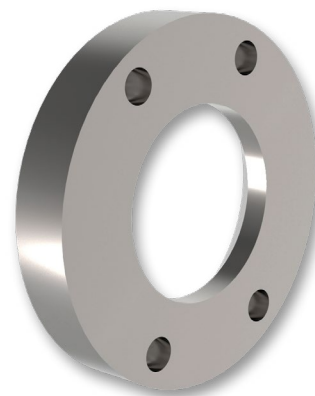

Adaptor Flange

Part #	Description	Material
SDAET040K	Adaptor NG40	ST37 Steel
SDAET063K	Adaptor NG50 & 63	ST37 Steel
SDAET080K	Adaptor NG80	ST37 Steel
SDAET100K	Adaptor NG100	ST37 Steel
SDAET125K	Adaptor NG125	ST37 Steel

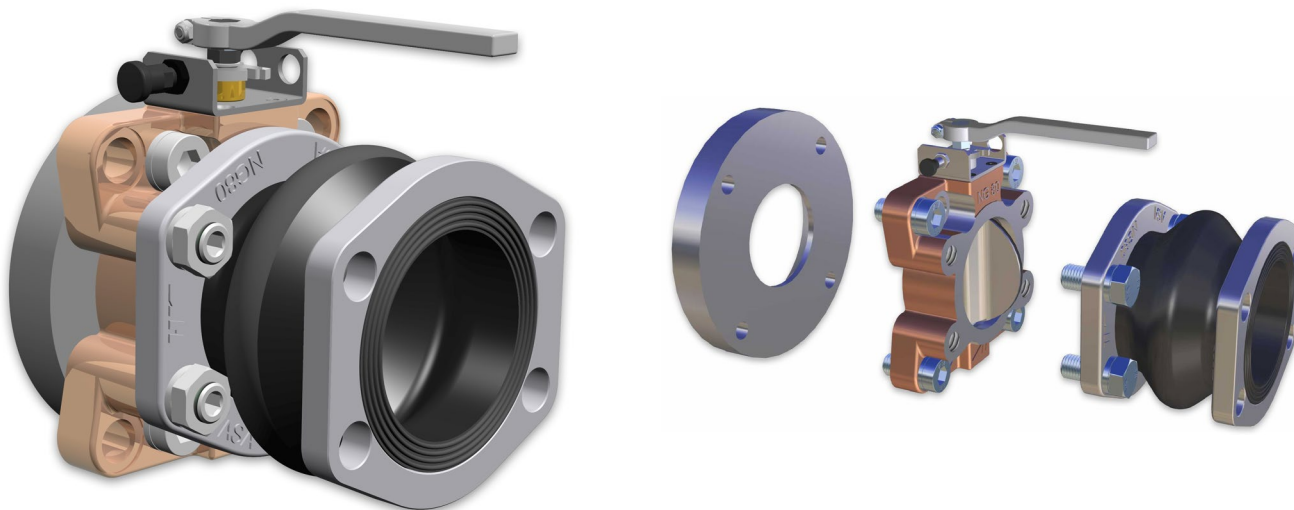



Compensators - SAE

Part #	Size	Material	Max Working Pressure
SDKSS025	NG25 SAE 1"	NBR/CR Steel	1.5 bar (absolute)
SDKSS032	NG32 SAE 1.1/4"	NBR/CR Steel	1.5 bar (absolute)
SDKSS040	NG40 SAE 1.1/2"	NBR/CR Steel	1.5 bar (absolute)
SDKSS050	NG50 SAE 2"	NBR/CR Steel	1.5 bar (absolute)
SDKSS063	NG63 SAE 2.1/2"	NBR/CR Steel	1.5 bar (absolute)
SDKSS080	NG80 SAE 3"	NBR/CR Steel	1.5 bar (absolute)
SDKSS092	NG90 SAE 3.1/2"	NBR/CR Steel	1.5 bar (absolute)
SDKSS100	NG100 SAE 4"	NBR/CR Steel	1.5 bar (absolute)
SDKSS126	NG125 SAE 5"	NBR/CR Steel	1.5 bar (absolute)

SAE Series



DIN Series



Compensators - DIN

Part #	Size	Material	Nominal Pressure
SDKHDD6D60032N00	NG32	NBR/CR Steel	Up to 16 bar
SDKHDD6D60040N00	NG40	NBR/CR Steel	Up to 16 bar
SDKHDD6D60050N00	NG50	NBR/CR Steel	Up to 16 bar
SDKHDD6D60065N00	NG65	NBR/CR Steel	Up to 16 bar
SDKHDD6D60080N00	NG80	NBR/CR Steel	Up to 16 bar
SDKHDD6D60100N00	NG100	NBR/CR Steel	Up to 16 bar
SDKHDD6D60125N00	NG125	NBR/CR Steel	Up to 16 bar
SDKHDD6D60200N00	NG200	NBR/CR Steel	Up to 16 bar
SDKHDD6D60300N00	NG300	NBR/CR Steel	Up to 16 bar



Limit Switches

Part #	Description
EAFSMK	Mechanical Limit Switch
EAFSIK	Inductive Limit Switch

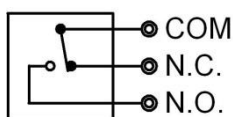
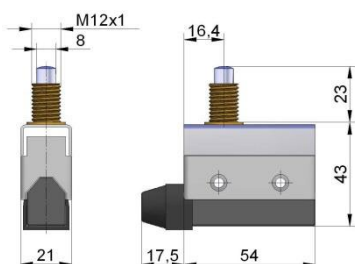

EAFSMK

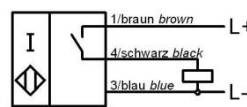

EAFSIK

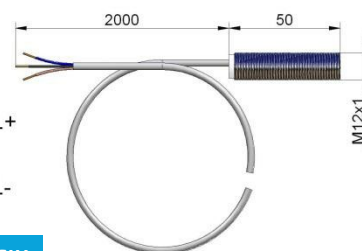



MBD Series 12v Fan (IP68)

Part #	Airflow	Power (watts)	Current (amps)	Dimensions (mm)					
				A	B	C	D	E	F
MBD1-190-A12H-AAA	Push	85	6.6	210	202	52	32	151	151
MBD1-190-A12H-BAA	Pull	102	7.9	210	202	52	32	151	151
MBD1-225-A12H-AAA	Push	83	6.4	247	238	52	28	139	206
MBD1-225-A12H-BAA	Pull	96	7.4	247	238	52	28	139	206
MBD1-255-A12H-AAA	Push	108	8.3	284.5	269	52	28	142	247
MBD1-255-A12H-BAA	Pull	111	8.5	284.5	269	52	28	142	247
MBD2-280-B12H-AAA	Push	121	9.3	310	294	64.5	28	155	269
MBD2-280-B12H-BAA	Pull	142	10.9	310	294	64.5	28	155	269
MBD2-305-B12H-AAA	Push	163	12.6	336	321	64.5	28	168	291.5
MBD2-305-B12H-BAA	Pull	150	11.5	336	321	64.5	28	168	291.5
MBD3-350-C12H-AAA	Push	242	18.6	383	367	74	28	191	331
MBD3-350-C12H-BAA	Pull	239	18.3	383	367	74	28	191	331
MBD3-385-C12H-AAA	Push	223	17.2	414	400	74	28	206.5	385.5
MBD3-385-C12H-BAA	Pull	245	18.8	414	400	74	28	206.5	385.5

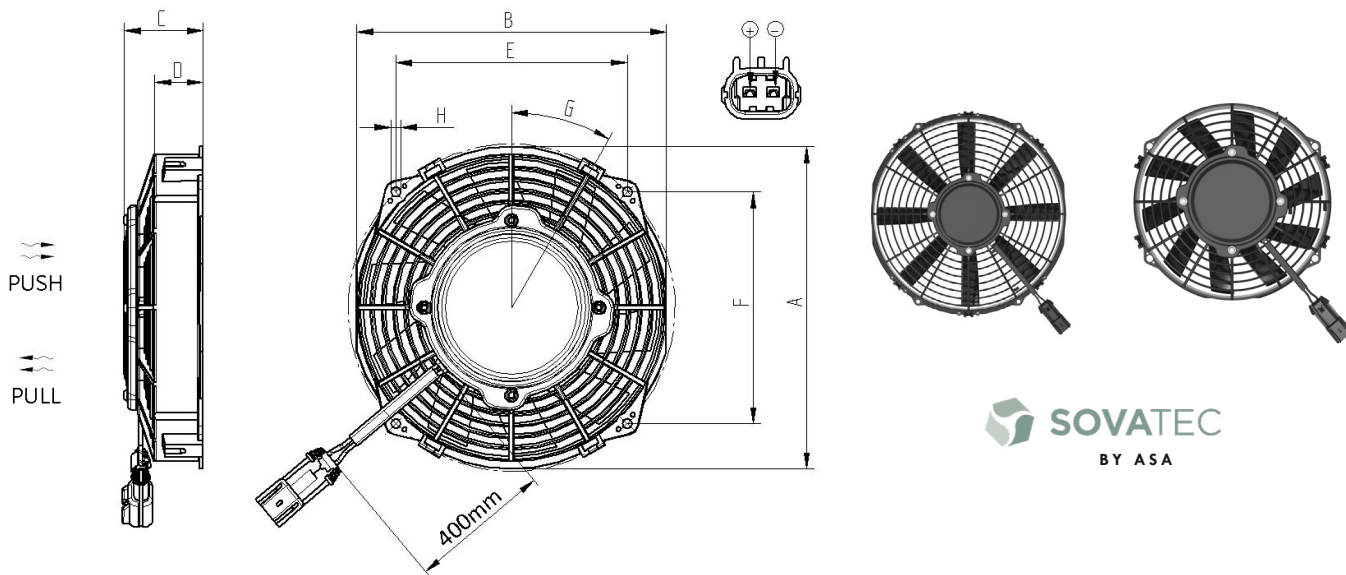

MBD Series 24v Fan (IP68)

Part #	Airflow	Power (watts)	Current (amps)	Dimensions (mm)					
				A	B	C	D	E	F
MBD1-190-A24H-AAA	Push	78	3	210	202	52	32	151	151
MBD1-190-A24H-BAA	Pull	89	3.4	210	202	52	32	151	151
MBD1-225-A24H-AAA	Push	107	4.1	247	238	52	28	139	206
MBD1-225-A24H-BAA	Pull	110	4.2	247	238	52	28	139	206
MBD1-255-A24H-AAA	Push	118	4.5	284.5	269	52	28	142	247
MBD1-255-A24H-BAA	Pull	119	4.6	284.5	269	52	28	142	247
MBD2-280-B24H-AAA	Push	117	4.5	310	294	64.5	28	155	269
MBD2-280-B24H-BAA	Pull	128	4.9	310	294	64.5	28	155	269
MBD2-305-B24H-AAA	Push	172	6.6	336	321	64.5	28	168	291.5
MBD2-305-B24H-BAA	Pull	177	6.8	336	321	64.5	28	168	291.5
MBD3-350-C24H-AAA	Push	231	8.9	383	367	74	28	191	331
MBD3-350-C24H-BAA	Pull	231	8.9	383	367	74	28	191	331
MBD3-385-C24H-AAA	Push	252	9.7	414	400	74	28	206.5	385.5
MBD3-385-C24H-BAA	Pull	248	9.5	414	400	74	28	206.5	385.5



23 Quinlan Road, Epping, VIC 3076

03 9397 6129

melbourne@asahydraulik.com

www.asahydraulics.com.au